

Service Manual

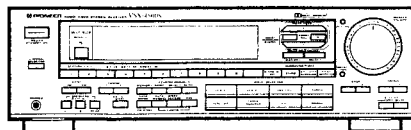

ORDER NO.
ARP1867

AUDIO/VIDEO STEREO RECEIVER

VSX-4500S

VSX-4400

- This manual is applicable to the VSX-4500S/KUC and VSX-4400/KUC types.

CONTENTS

1. SAFETY INFORMATION	2	7. ADJUSTMENTS	32
2. EXPLODED VIEWS AND PARTS LIST	3	8. IC INFORMATION	35
3. PRECAUTIONS ON SERVICE	6	9. REMOTE CONTROL UNIT (AXD1104)	38
4. SCHEMATIC DIAGRAM	7	10. PANEL FACILITIES	43
5. P.C.BOARDS CONNECTION DIAGRAM	15	11. SPECIFICATIONS	49
6. ELECTRICAL PARTS LIST	27		

PIONEER ELECTRONIC CORPORATION 4-1, Meguro 1-Chome, Meguro-ku, Tokyo 153, Japan

PIONEER ELECTRONICS SERVICE INC. P.O. Box 1760, Long Beach, California 90801 U.S.A.

PIONEER ELECTRONICS OF CANADA, INC. 505 Cochrane Drive, Markham, Ontario L3R 8E3 Canada

PIONEER ELECTRONIC [EUROPE] N.V. Keetberglaan 1, 2740 Beveren, Belgium

PIONEER ELECTRONICS AUSTRALIA PTY. LTD. 178-184 Boundary Road, Braeside, Victoria 3195, Australia TEL: [03] 580-9911

© **PIONEER ELECTRONIC CORPORATION 1989**

YA AUG. 1989 Printed in Japan.

1. SAFETY INFORMATION

1. SAFETY PRECAUTIONS

The following check should be performed for the continued protection of the customer and service technician.

LEAKAGE CURRENT CHECK

Measure leakage current to a known earth ground (water pipe, conduit, etc.) by connecting a leakage current tester such as Simpson Model 229-2 or equivalent between the earth ground and all exposed metal parts of the appliance (input/output terminals, screwheads, metal overlays, control shaft, etc.). Plug the AC line cord of the appliance directly into a 120V AC 60Hz outlet and turn the AC power switch on. Any current measured must not exceed 0.5mA.

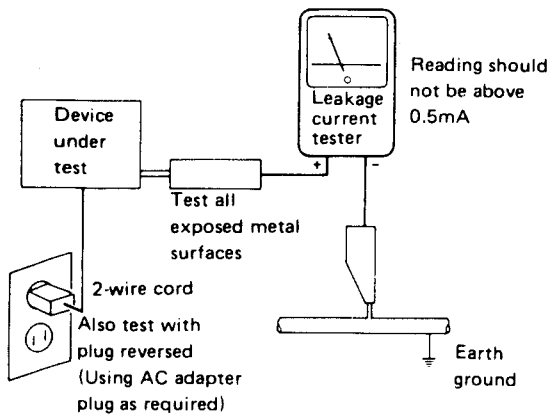

AC Leakage Test

ANY MEASUREMENTS NOT WITHIN THE LIMITS OUTLINED ABOVE ARE INDICATIVE OF A POTENTIAL SHOCK HAZARD AND MUST BE CORRECTED BEFORE RETURNING THE APPLIANCE TO THE CUSTOMER.

2. PRODUCT SAFETY NOTICE

Many electrical and mechanical parts in the appliance have special safety related characteristics. These are often not evident from visual inspection nor the protection afforded by them necessarily can be obtained by using replacement components rated for voltage, wattage, etc. Replacement parts which have these special safety characteristics are identified in this Service Manual.

Electrical components having such features are identified by marking with a Δ on the schematics and on the parts list in this Service Manual.

The use of a substitute replacement component which does not have the same safety characteristics as the PIONEER recommended replacement one, shown in the parts list in this Service Manual, may create shock, fire, or other hazards.

Product Safety is continuously under review and new instructions are issued from time to time. For the latest information, always consult the current PIONEER Service Manual. A subscription to, or additional copies of, PIONEER Service Manual may be obtained at a nominal charge from PIONEER.

2. EXPLODED VIEWS AND PARTS LIST

NOTES:

- Parts without part number cannot be supplied.
- The Δ mark found on some component parts indicates the importance of the safety factor of the part. Therefore, when replacing, be sure to use parts of identical designation.
- Parts marked by "⊙" are not always kept in stock. Their delivery time may be longer than usual or they may be unavailable.

Parts list of Exterior and Packing

Mark	No.	Parts No.	Description	Mark	No.	Parts No.	Description
Δ	1	2SA1263N	TRANSISTOR Q 5		51	AWZ2584	MAIN ASSY
Δ	2	2SA1302	TRANSISTOR Q 3		52	REAR SP ASSY
Δ	3	2SA1302	TRANSISTOR Q 4		53
Δ	4	2SC3180N	TRANSISTOR Q 6		54	EQ ASSY
Δ	5	2SC3281	TRANSISTOR Q 1		55	AWZ2587	FRONT ASSY
Δ	6	2SC3281	TRANSISTOR Q 2		56	VOL ASSY
Δ	7	ATS1215	POWER TRANSFORMER T 1		57	REAR AMP ASSY
Δ	8	AEK-125	FUSE(4A) FU 3		58	PRIMARY ASSY
Δ	9	AEK-125	FUSE(4A) FU 4		59	TERMINAL SCREW
Δ	10	AEK1002	FUSE(8A) FU 1		60	AKM1061	PLUG
Δ	11	ADG1057	AC POWER CORD		61	CHASSIS
	12	AEC-818	MICA SHEET		62	REAR PANEL
	13	AEP-313	MICA SHEET		63	BOTTOM PLATE
	14	AMR1350	INSULATOR ASSY		64	HEAT SINK
	15	AMR1353	INSULATOR ASSY		65	PLATE
	16	ABA-297	SCREW (STEEL)		66	CUSHION
	17	ABA-298	SCREW		67
	18	ABA1006	SCREW (STEEL)		68	SHEET
	19	ABA1011	SCREW (STEEL)		69	NYLON RIVET
	20	ABA1093	SCREW (STEEL)		70	PIN GROMMET
	21	ABN-065	NUT		71
	22	BBZ26P080FMC	SCREW		72
	23	FBT40P080FZK	SCREW		73
	24	PBZ25P100FMC	SCREW		74
	25	VMZ30P060FMC	SCREW		75
	26	ANB1332	FRONT PANEL (VSX-4500S)		76
		ANB1346	FRONT PANEL (VSX-4400)		77	AHG1016	SHEET
	27	AMB1516	PANEL BASE				
	28	AAK1772	PANEL				
	29	AAK1773	FL FILTER				
	30	AAM1029	NAME PLATE				
	31	AAB1119	MASTER VOL ASSY				
	32	AAD1398	TACT KNOB				
	33	AAD1587	SP SW KNOB				
	34	AAD1588	STATION KNOB				
	35	AAD1589	SURROUND KNOB				
	36	AAD1590	FUNCTION KNOB				
	37	AAD1591	FUNCTION KNOB				
	38				
	39	ARB1207	INSTRUCTION MANUAL				
	40	AXD1104	REMOTE CONSOLE UNIT (VSX-4500S)				
		AXD1105	REMOTE CONSOLE UNIT (VSX-4400)				
	41	AZN1811	BATTERY COVER (VSX-4400)				
	42	ADH1004	FM ANTENNA				
	43	ATB1004	LOOP ANTENNA				
	44	AHA1020	STYROL PROTECTOR				
	45	AHA1021	STYROL PROTECTOR				
	46	AHD1719	PACKING CASE (VSX-4500S)				
		AHD1720	PACKING CASE (VSX-4400)				
	47	AZN1934	BONNET COVER				
	48	AWE1140	TUNER ASSY				
	49				
	50	SP. SW ASSY				

Exterior

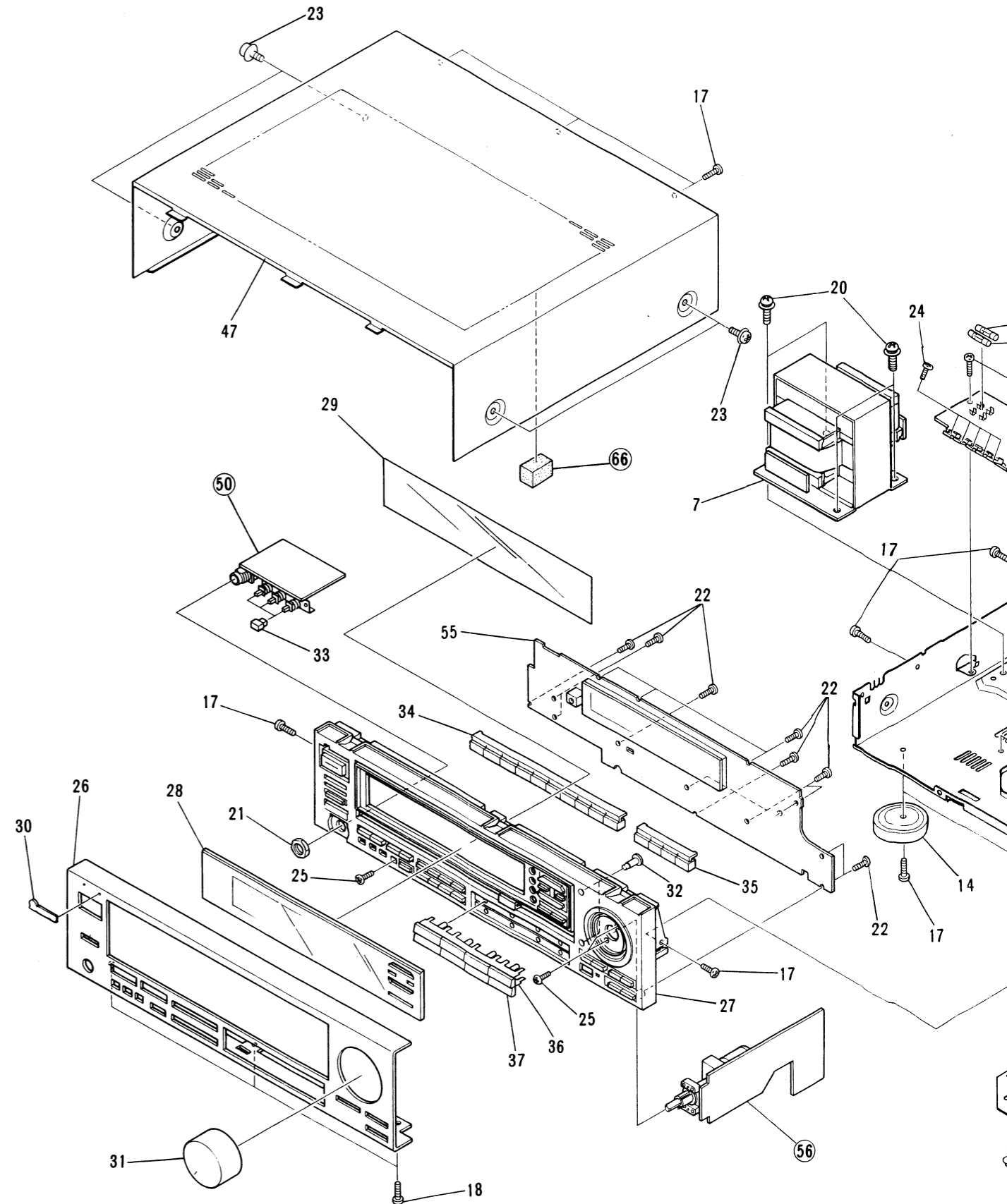

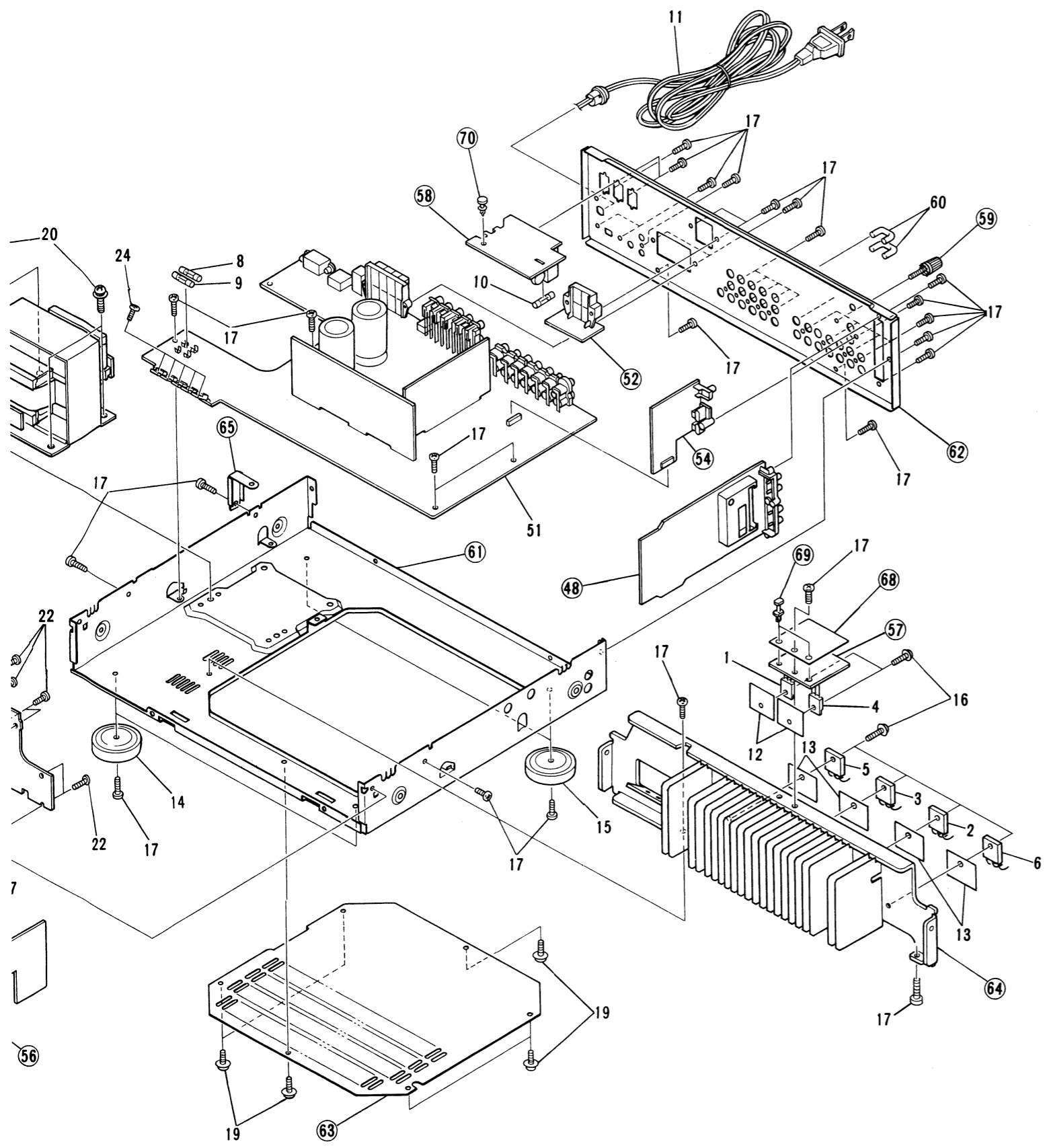

A
B
C
D

Packing

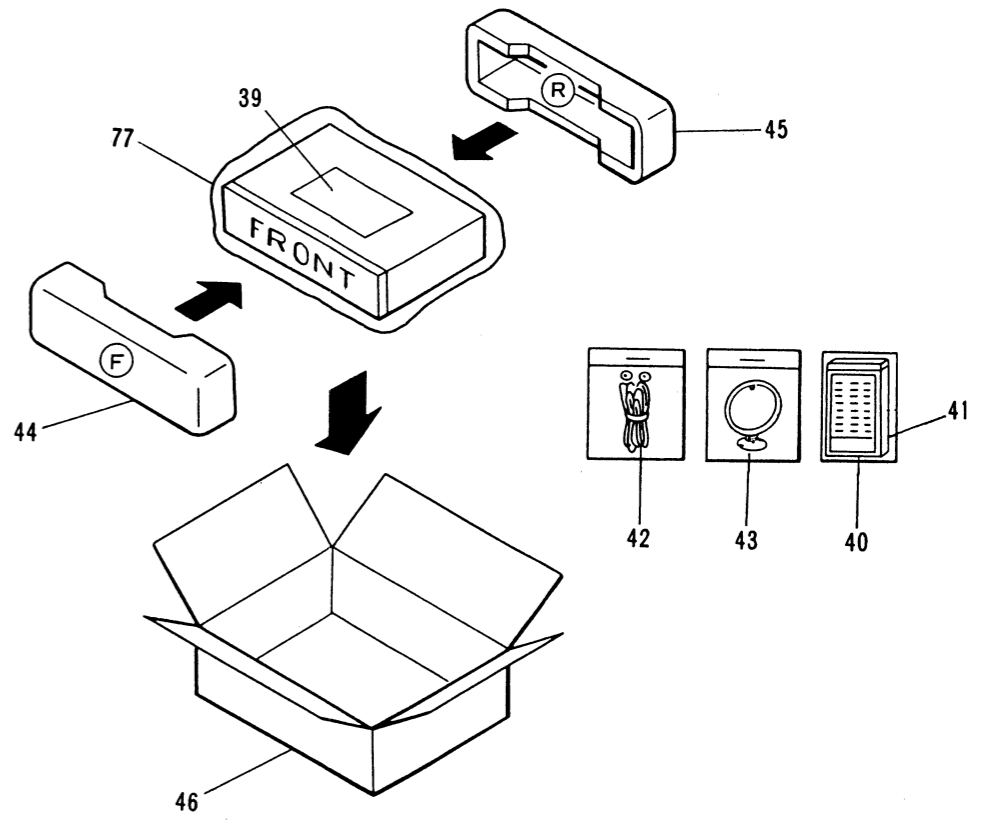

4. SCHEMATIC DIAGRAM

IC451	AN7470P	Q472	2SC1740SLN	D431-D435	1SS252
IC431	LA1265S	Q451	2SC2603	D401-D403	1SV147
IC471	LM7001	Q403, Q421	2SC2668		
		Q402	2SC2786		
		Q405	2SK161		
Q473, Q474	RN2201	Q401	2SK241		
Q454	2SA933S	Q471	2SK246		
Q452, Q453	2SC1740S				

TUNER ASSEMBLY (AWE1140)

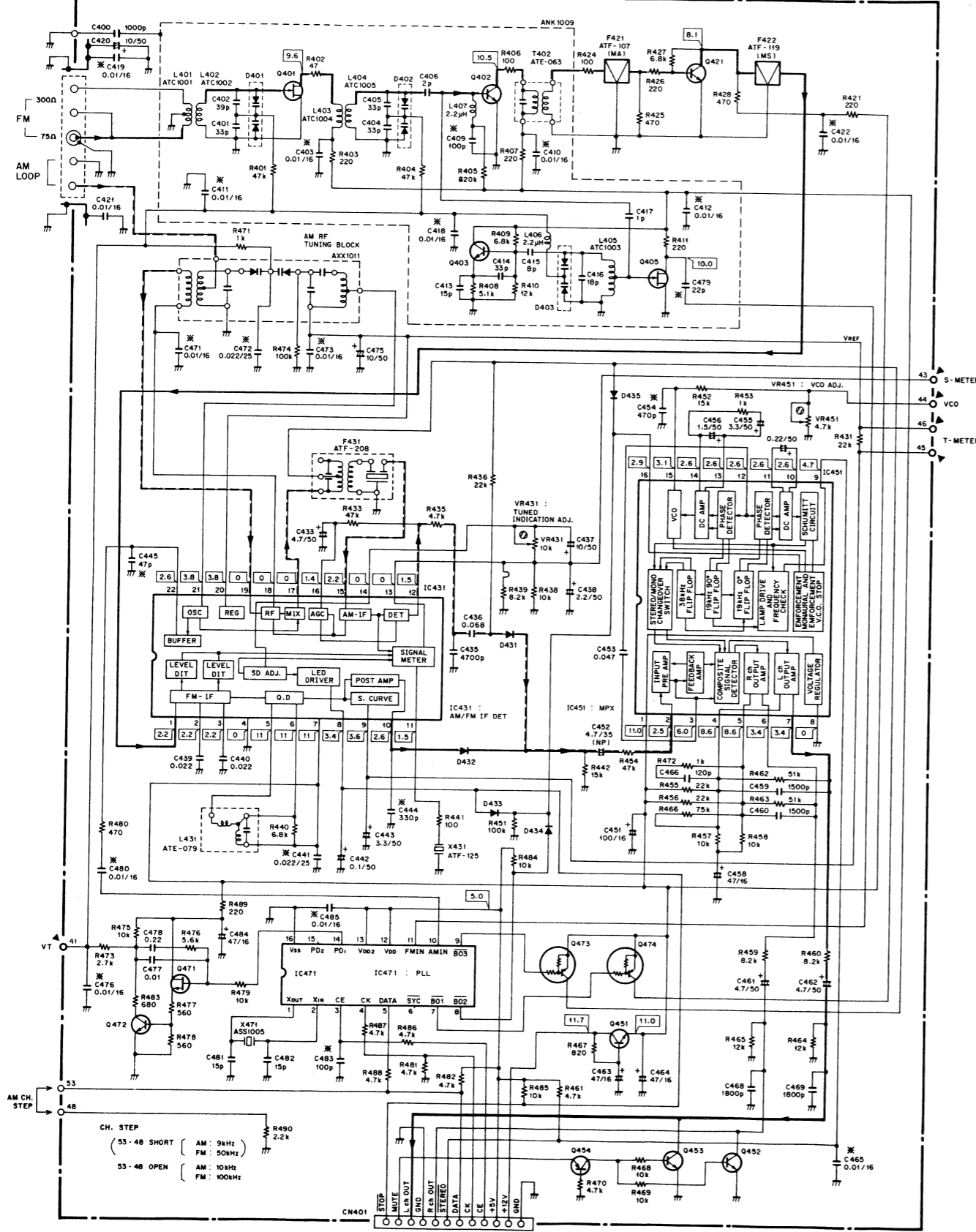

To MAIN ASSEMBLY

EQ ASSEMBLY

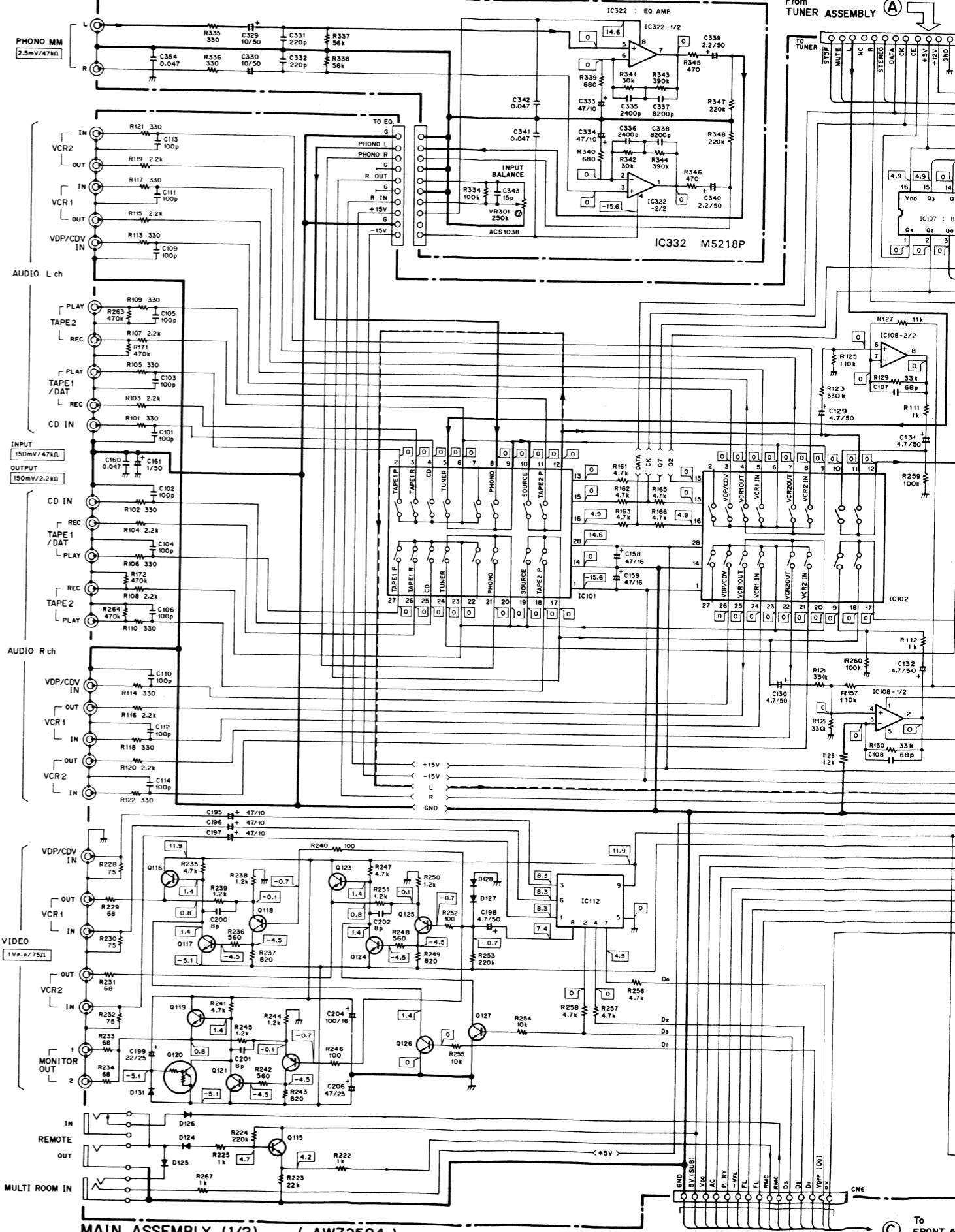

MAIN ASSEMBLY (1/2) (AWZ2584)

To FRONT A

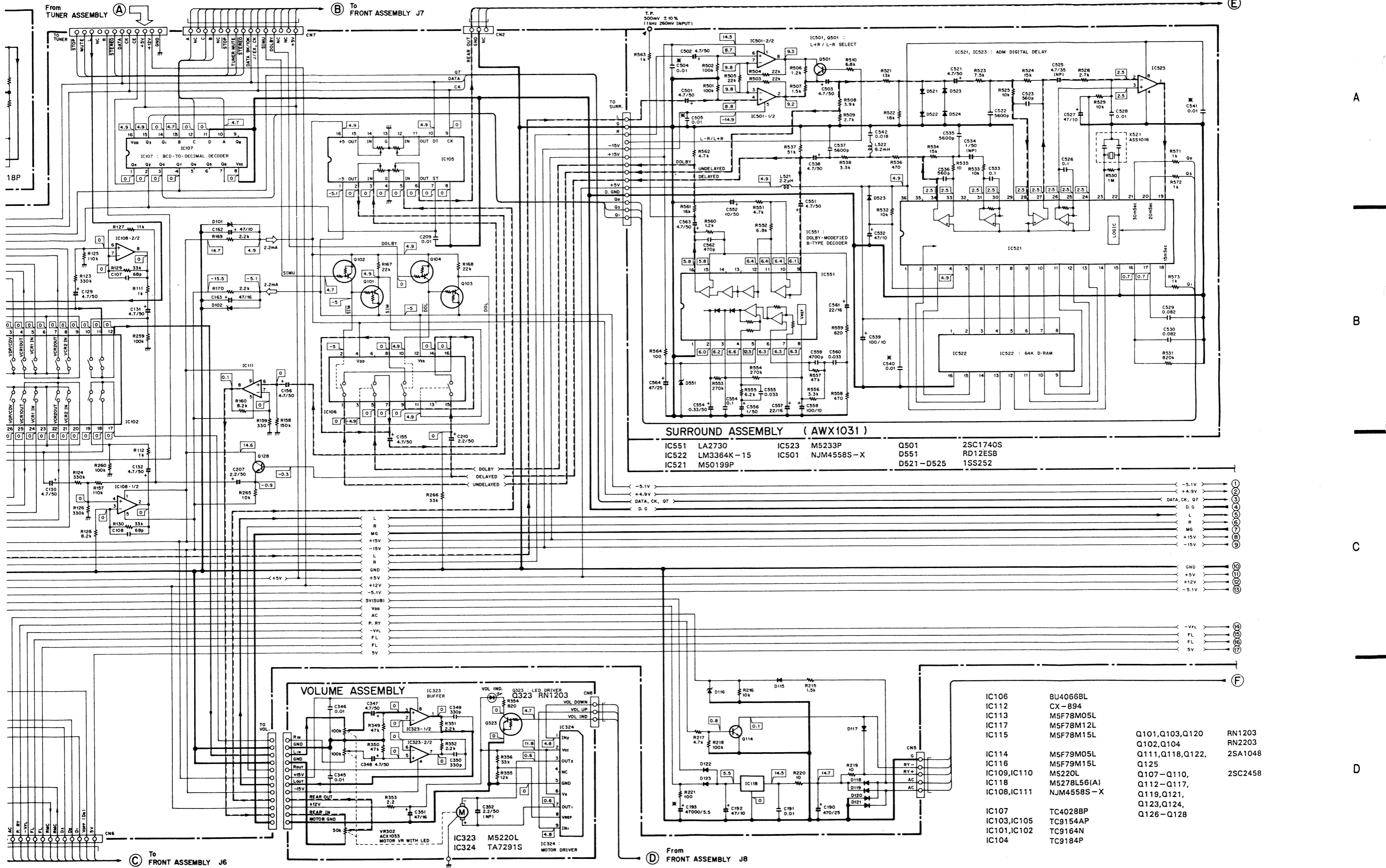

SURROUND ASSEMBLY (AWX1031)

IC551	LA2730	IC523	M5233P	Q501	2SC1740S
IC522	LM3364K-15	IC501	NJM4558S-X	D551	RD12ESB
IC521	M50199P			D521-D525	1SS252

IC106	BU4066BL	Q101, Q103, Q120	RN1203
IC112	CX-894	Q102, Q104	RN2203
IC113	M5F78M05L	Q111, Q118, Q122, Q125	2SA1048
IC117	M5F78M12L	Q107-Q110, Q112-Q117, Q119, Q121, Q123, Q124, Q126-Q128	2SC2458
IC115	M5F78M15L		
IC114	M5F79M05L		
IC116	M5F79M15L		
IC109, IC110	M5220L		
IC118	M5278L56(A)		
IC108, IC111	NJM4558S-X		
IC107	TC4028BP		
IC103, IC105	TC9154AP		
IC101, IC102	TC9164N		
IC104	TC9184P		

A
B
C
D

MAIN ASSEMBLY (2/2) (AWZ2584)

AMP ASSEMBLY (AWH 1008)

D601-D612, D661-D666 1SS252

REAR A

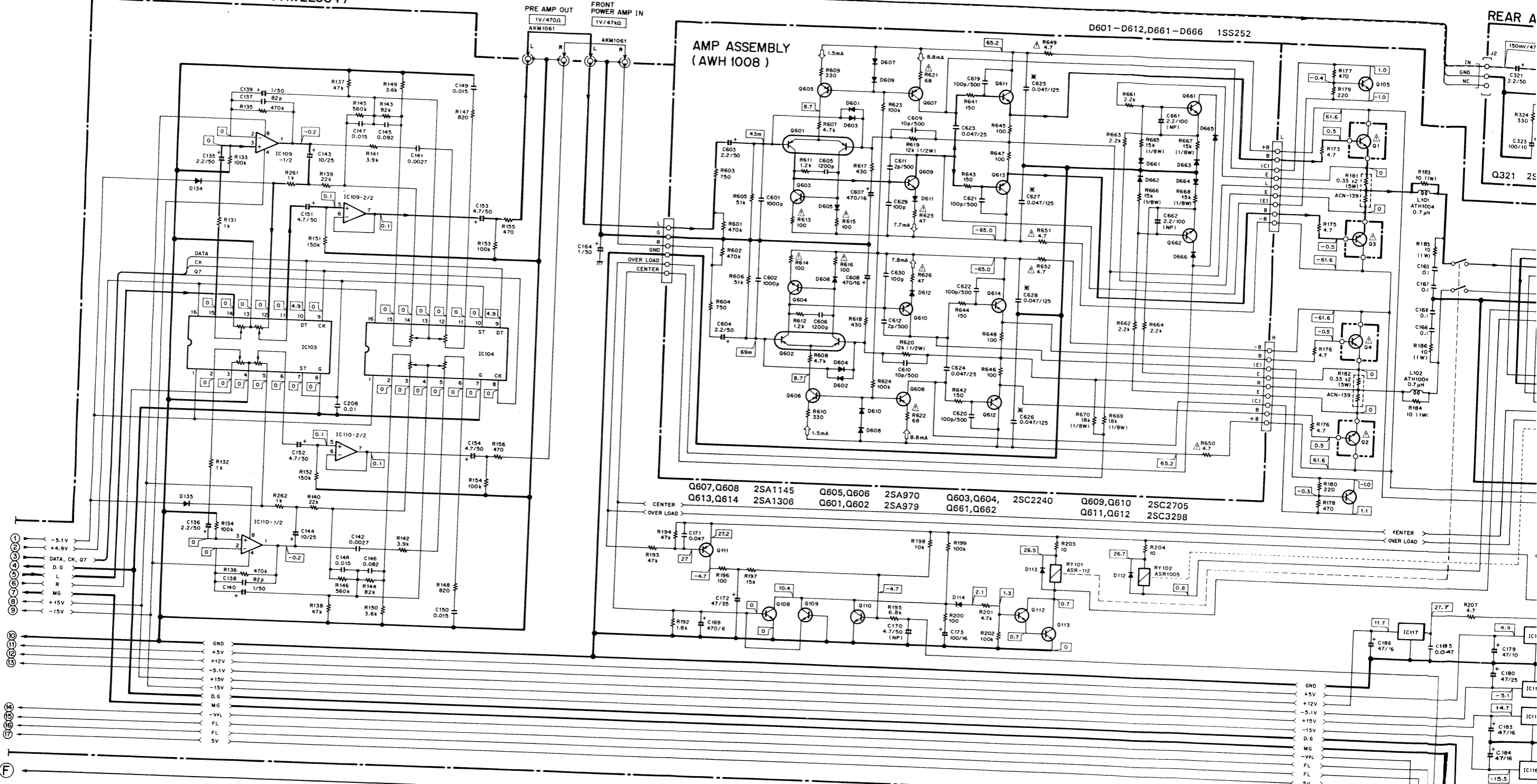

- Q105, Q106 2SC2603
- D109 D5SB20F
- D114 HZS9AL
- D101, D102, D116, D133 RD5.1ESB2
- D118-D121 1SR139-400
- D110-D113, D115, 1SS252
- D117, D122,
- D124-D128, D131, D132, D134, D135
- D123 1S1555
- D107, D108 1S2471
- D103-D106 10E2FD

1. RESISTORS:
 Indicated in Ω, 1/4W, 1/8W, ±5% tolerance unless otherwise noted
 k:kΩ, M:MΩ, (F): ±1%, (G): ±2%, (K): ±10%(M), ±20% tolerance
2. CAPACITORS:
 Indicated in capacity (μF)/voltage(V) unless otherwise noted p:pF
 Indication without voltage is 50V except electrolytic capacitor.
3. VOLTAGE, CURRENT:
 □: Signal voltage at 100V+100V(Front), 15V+15V(Rear),
 8ohm output (1kHz)
 □: DC voltage (V) at no input signal
 Value in () is DC voltage at rated power.
 ◀: DC current at no input signal

4. OTHERS:
 →: Signal route.
 ⊙: Adjusting point.
 The Δ mark found on some component parts indicates the importance of the safety factor of the part. Therefore, when replacing, be sure to use parts of identical designation.
 * marked capacitors and resistors have parts numbers.
 This is the basic schematic diagram, but the actual circuit may vary due to improvements in design.

5. SWITCHES
 S102 Push switch SP A-SP B-REAR
 S304 Tact switch
 S301-S303, S305-S338, Tact switch
 S340-S351

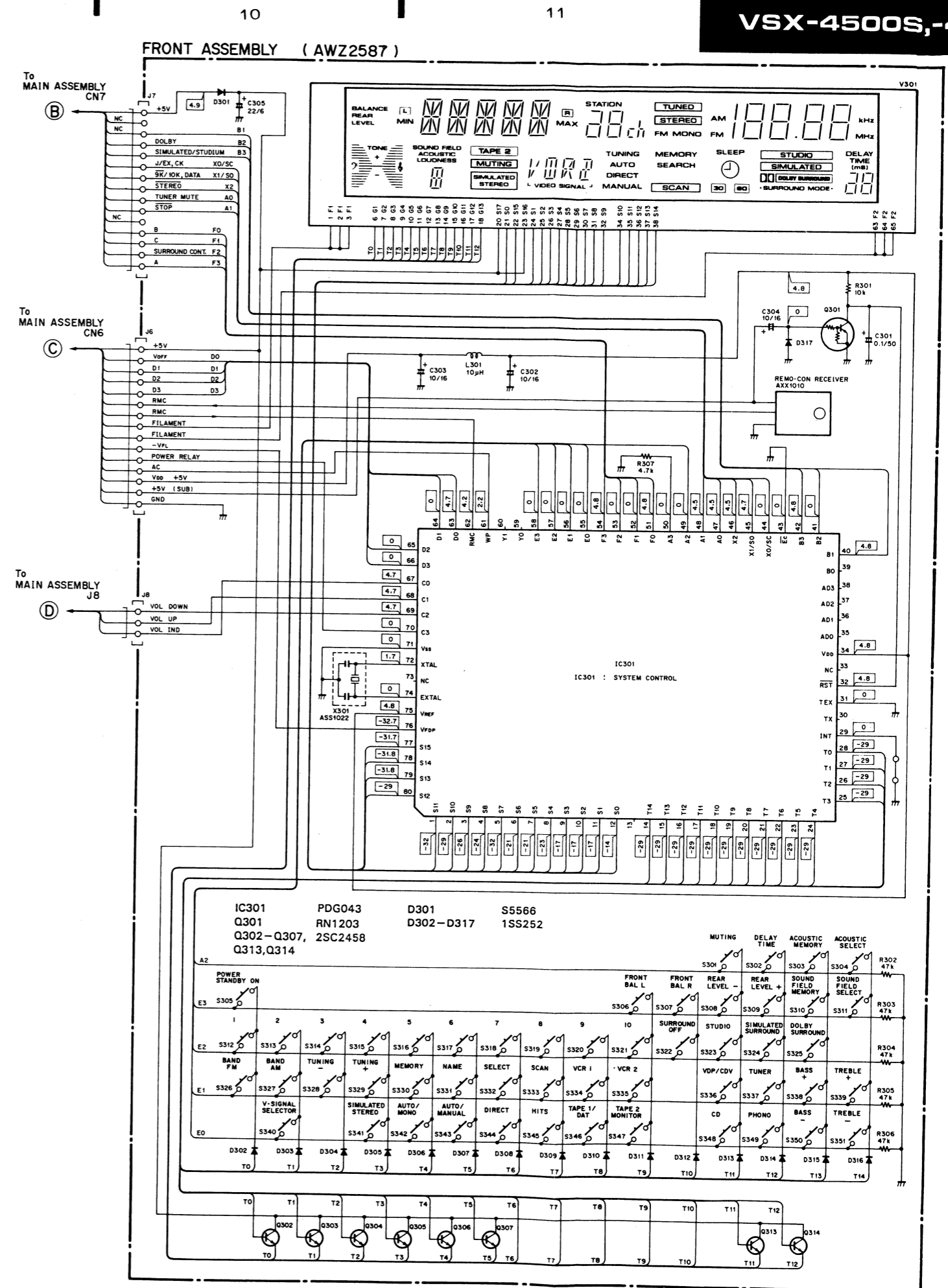
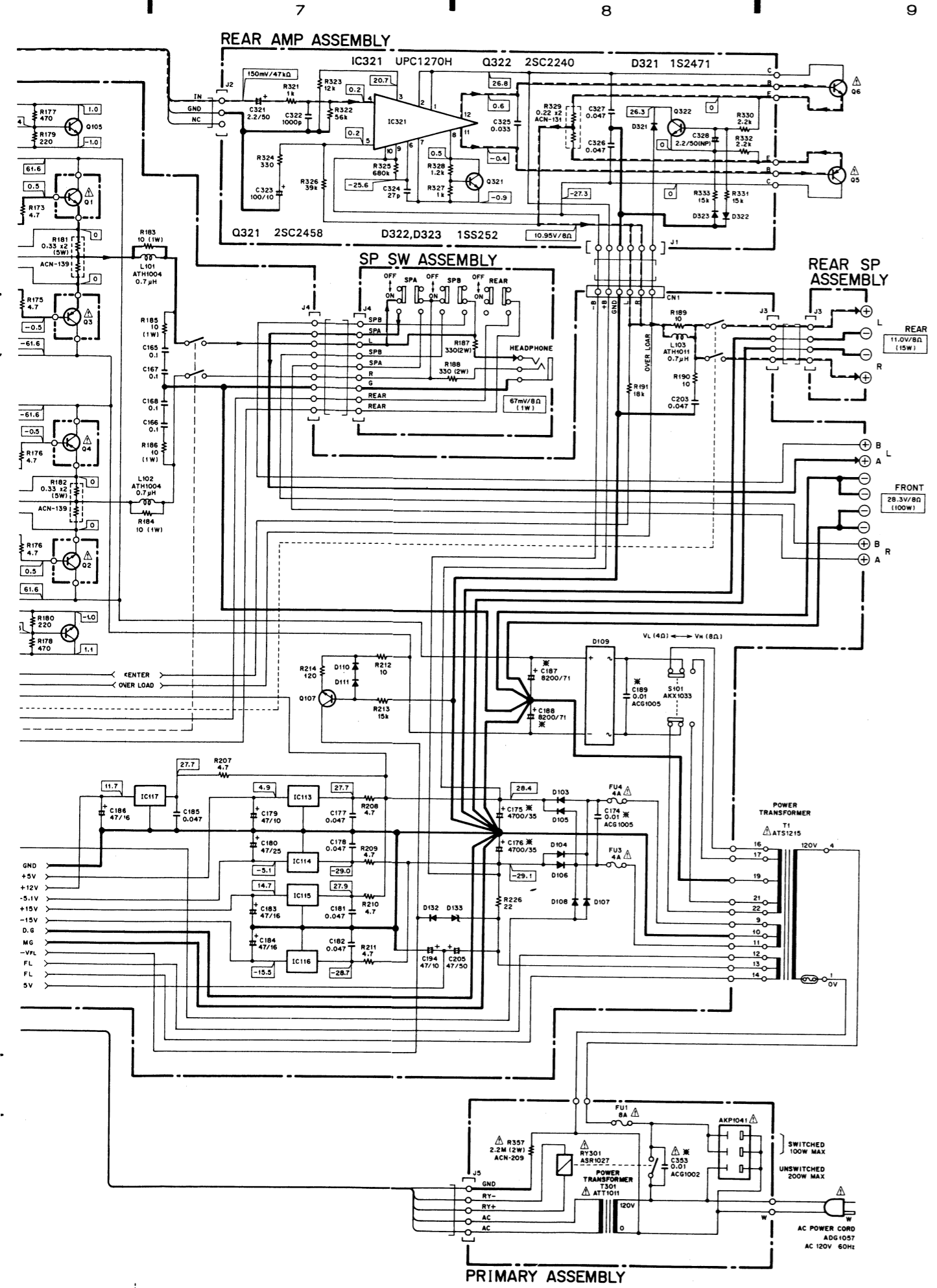

5. P.C.BOARDS CONNECTION DIAGRAM

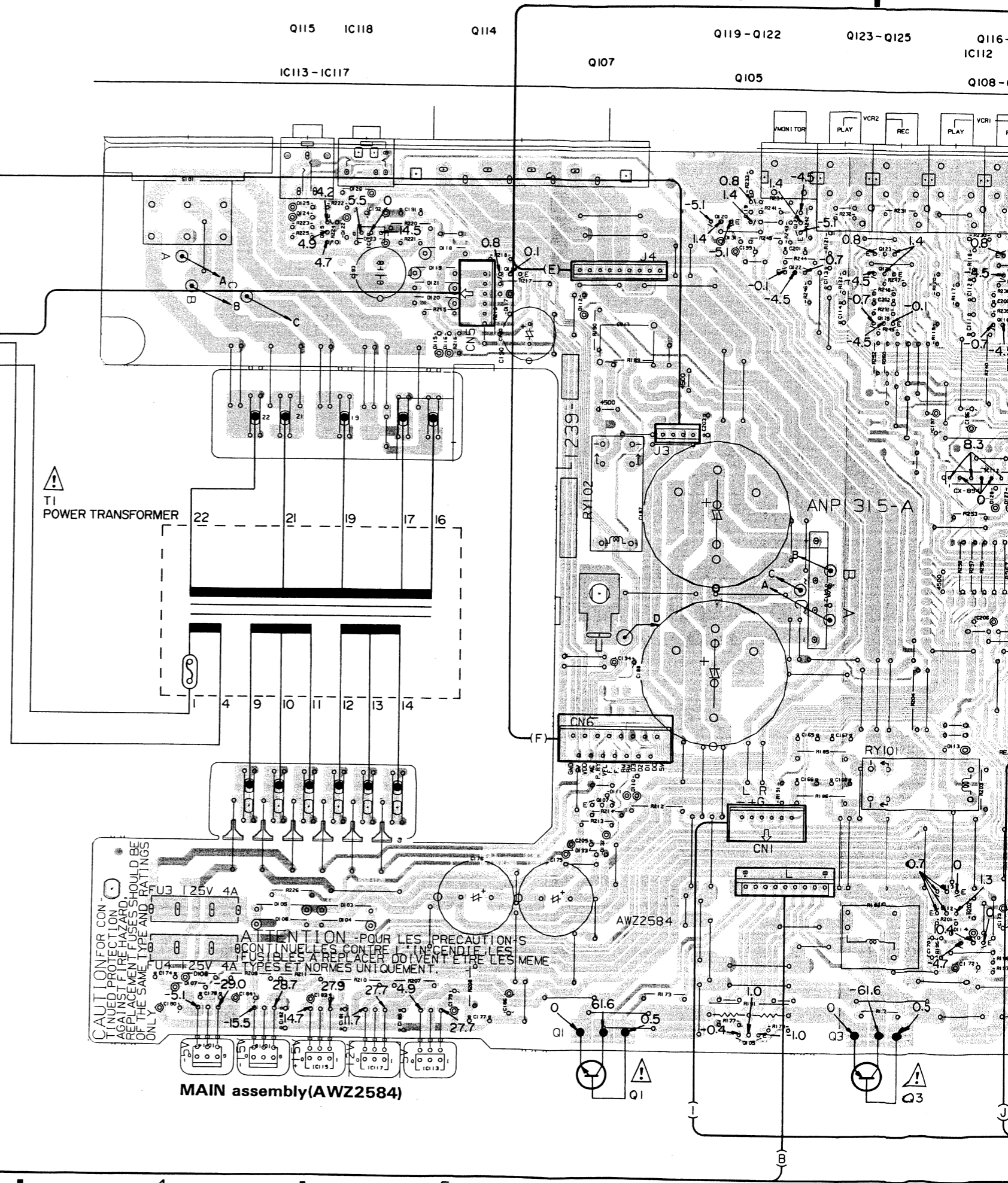
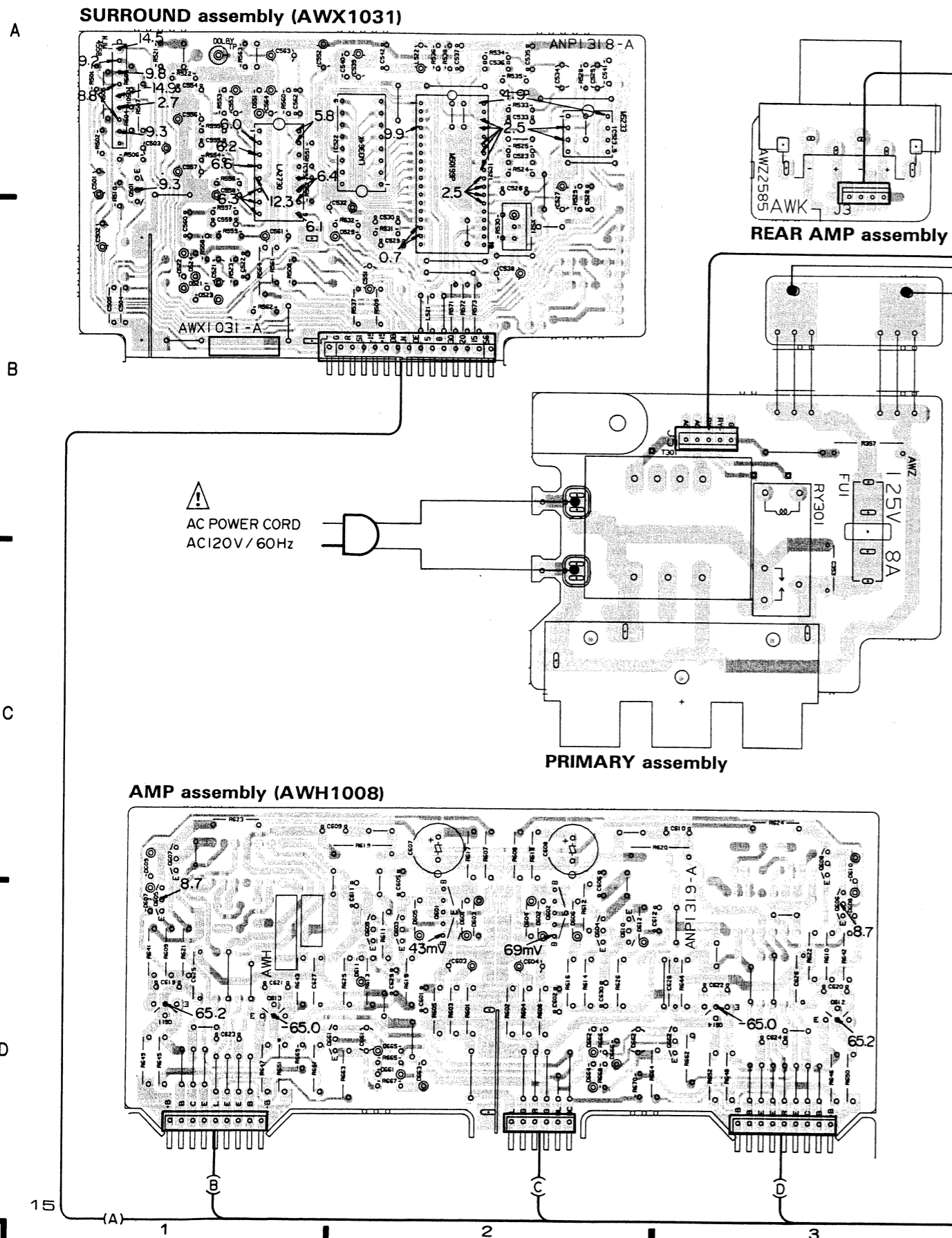

7

8

9

10

11

12

Q123-Q125 Q116-Q118 IC101
 IC112 Q126-Q127 IC106 IC102 IC108
 Q108-Q113 IC105 IC111 Q128 Q106 IC109 IC104 IC110 IC107
 Q101-Q104

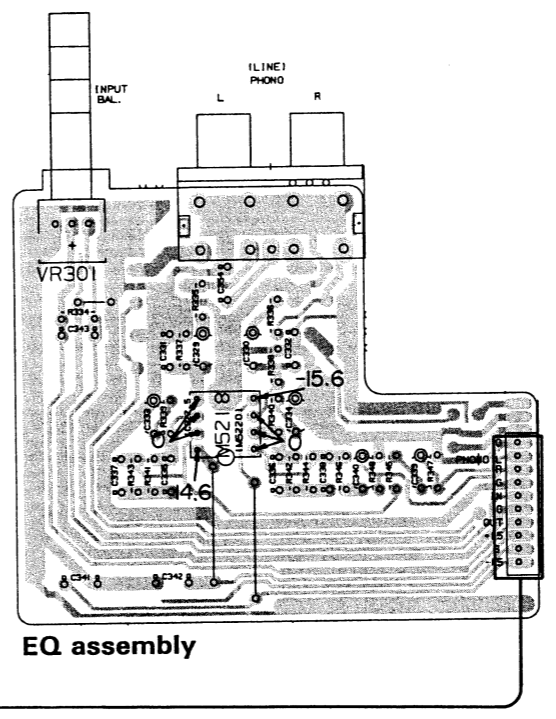
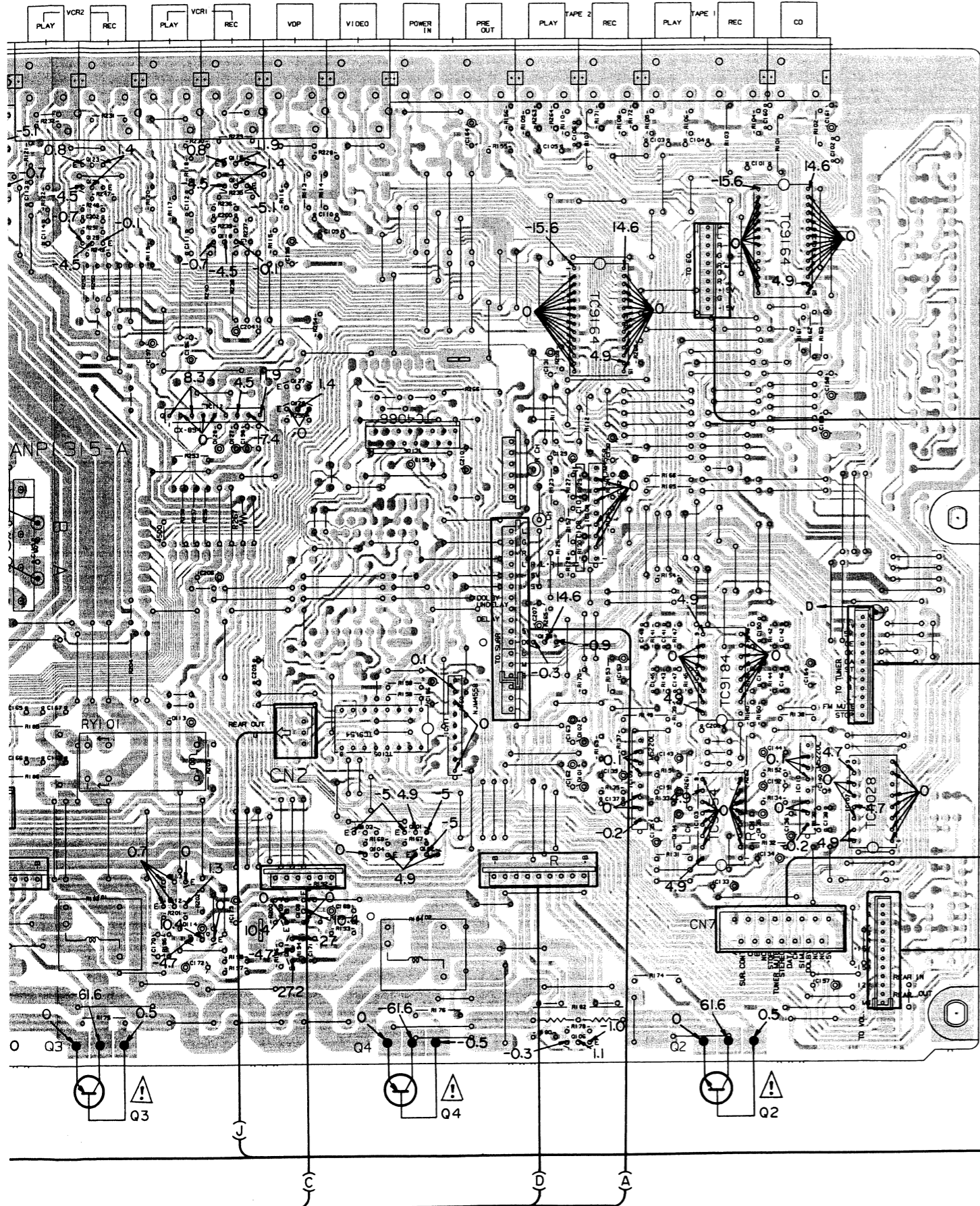

EQ assembly

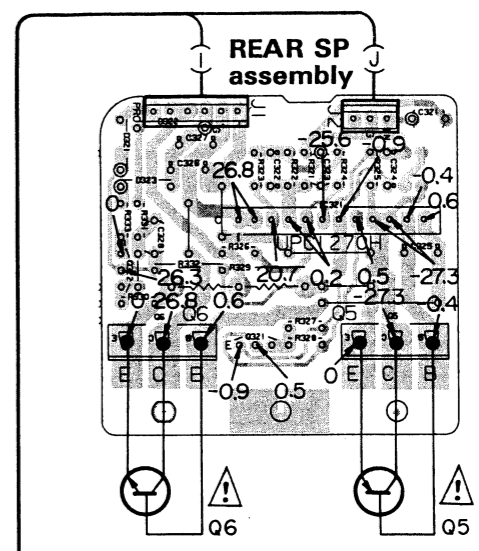

REAR SP assembly

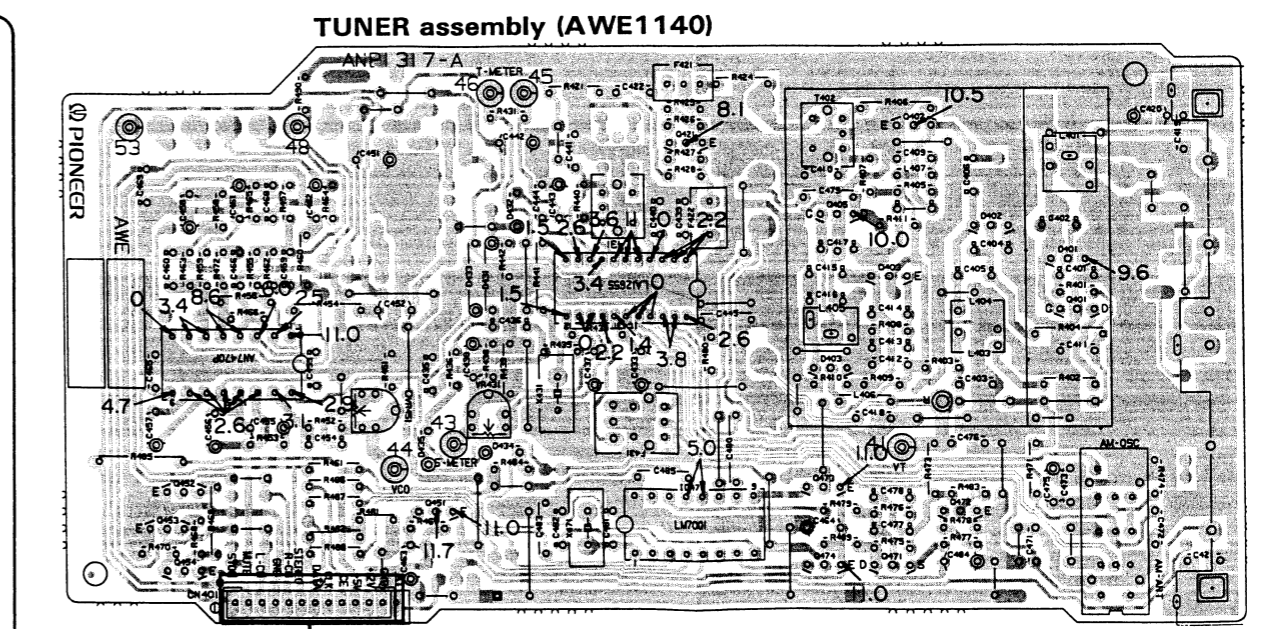

TUNER assembly (AWE1140)

IC451 Q451 IC431 Q421 Q405 Q402 Q401
 Q452-Q454 IC471 Q471-Q474

7

8

9

10

11

12

A

B

C

D

E,F

G,H

A

1 2 3 4 5

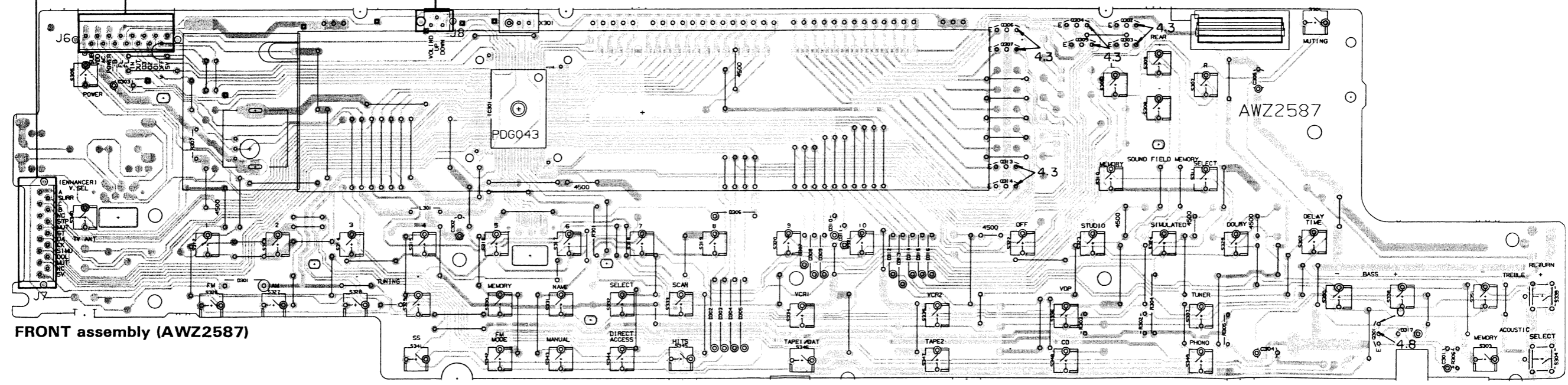
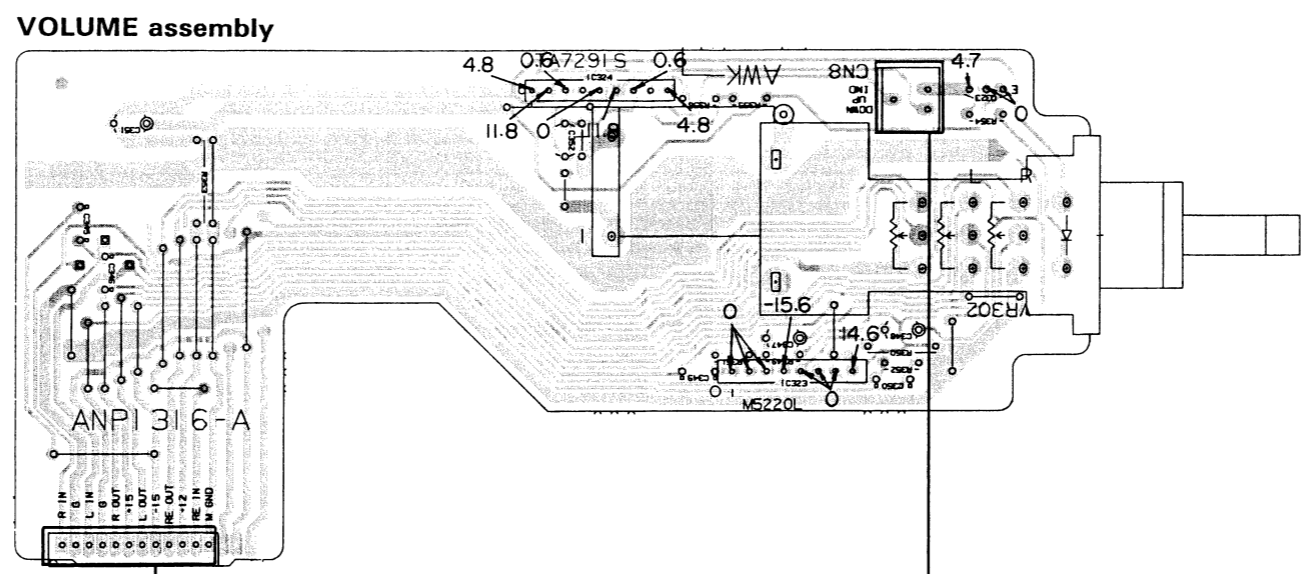
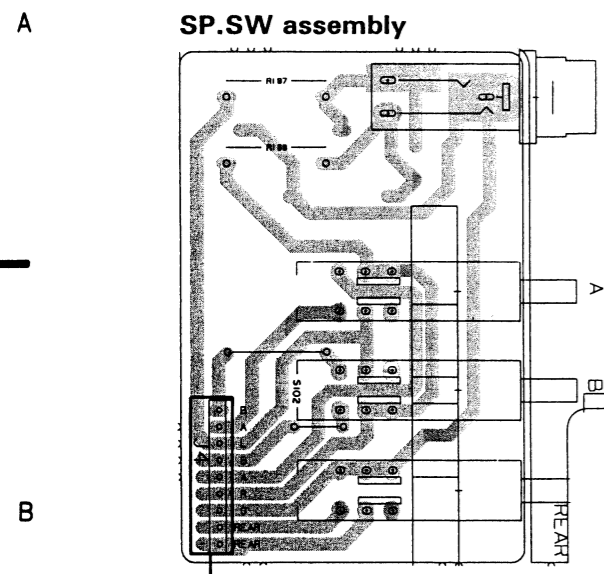

NOTE

1. This P.C.B connection diagram is viewed from the parts mounted side.
2. The parts which have been mounted on the board can be replaced with those shown with the corresponding wiring symbols listed in the following Table.

P.C.B. pattern diagram indication	Corresponding part symbol	Part Name
		Transistor
		Radiator type transistor
		Diode
		Resistor
		Capacitor (Polarity)
		Capacitor (Non-polarity)

Others

P.C.B. pattern diagram indication	Part Name
IC	IC
S	Switch
RY	Relay
L	Coil
F	Filter
VR	Variable resistor or Semi-fixed resistor

3. The capacitor terminal marked with ⊕ (double circles) shows negative terminal.
4. The diode terminal marked with ⊕ (double circles) shows cathode side.
5. The transistor terminal to which E is affixed shows the emitter.

A
B
C
D

A
B
C
D

1 2 3 4 5 6

NOTE:
This picture shows the foil side of the printed circuit.

A

B

C

D

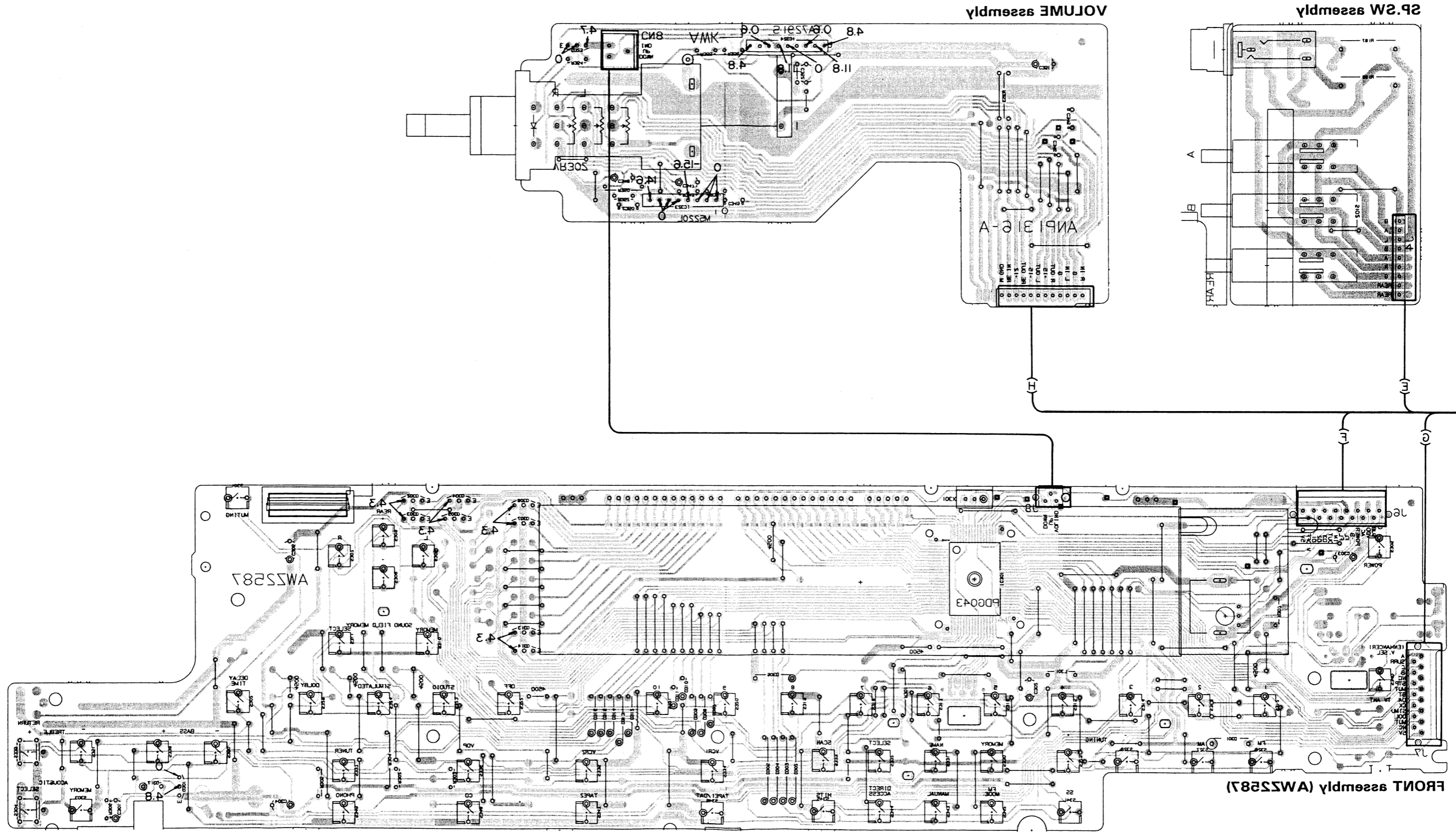

A

B

C

D

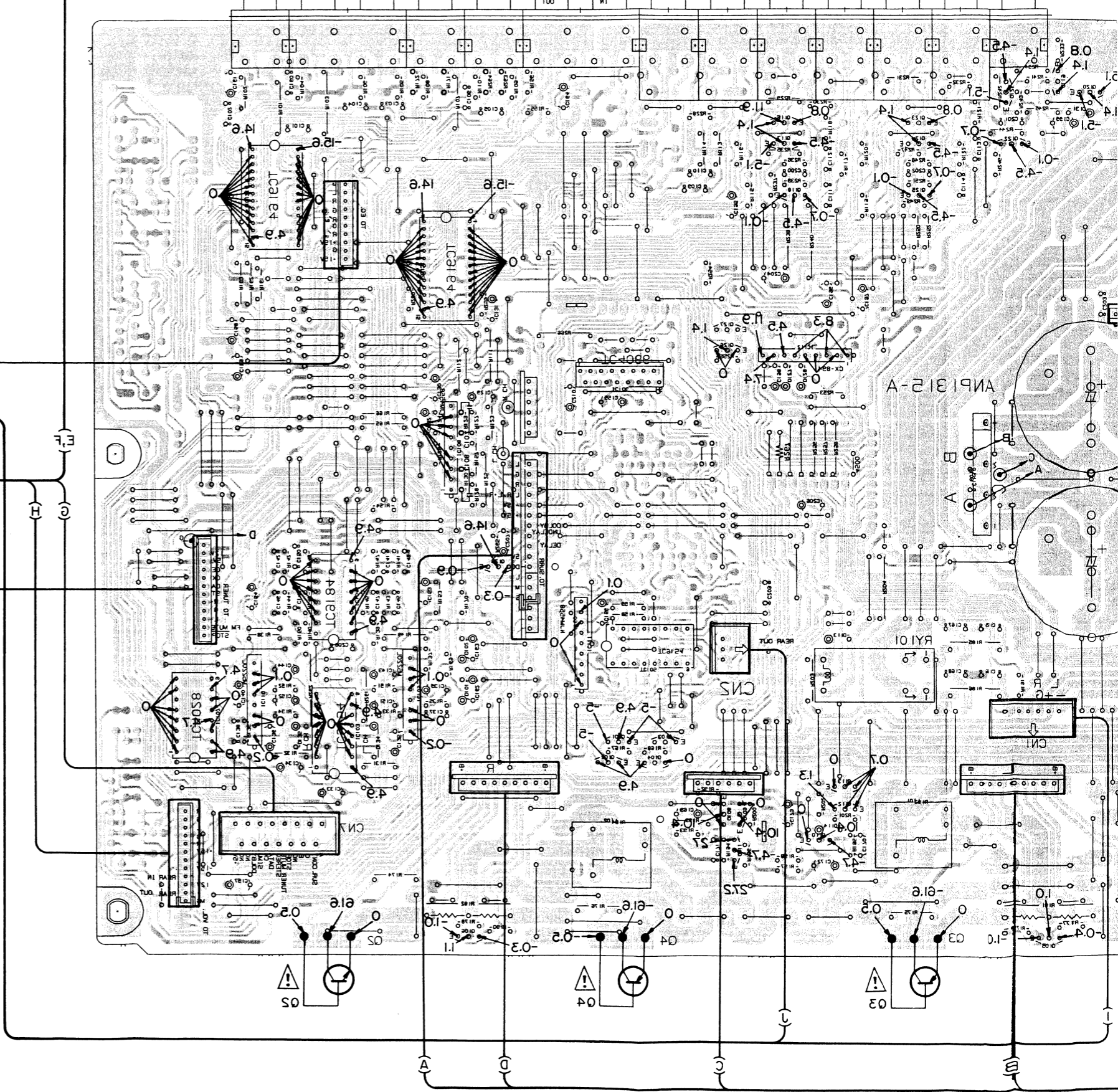
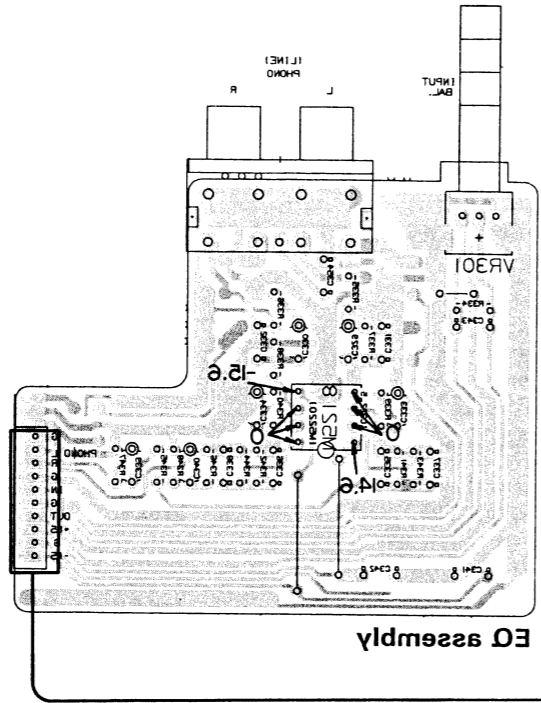
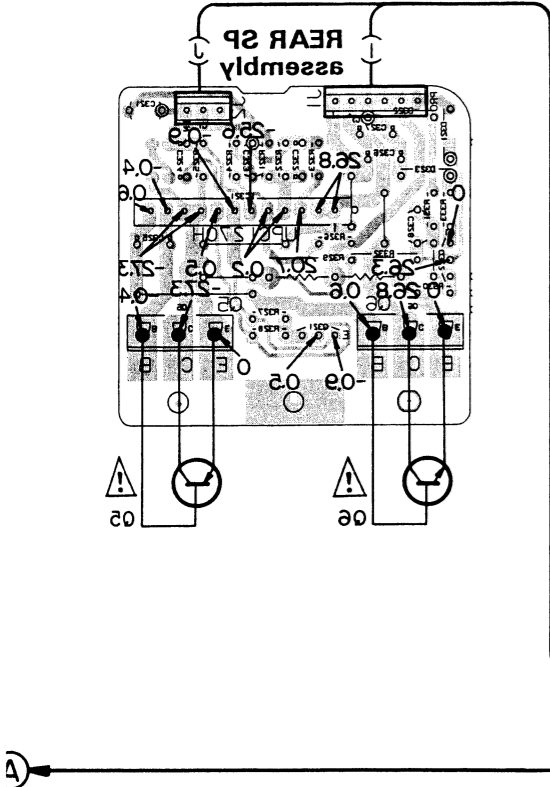
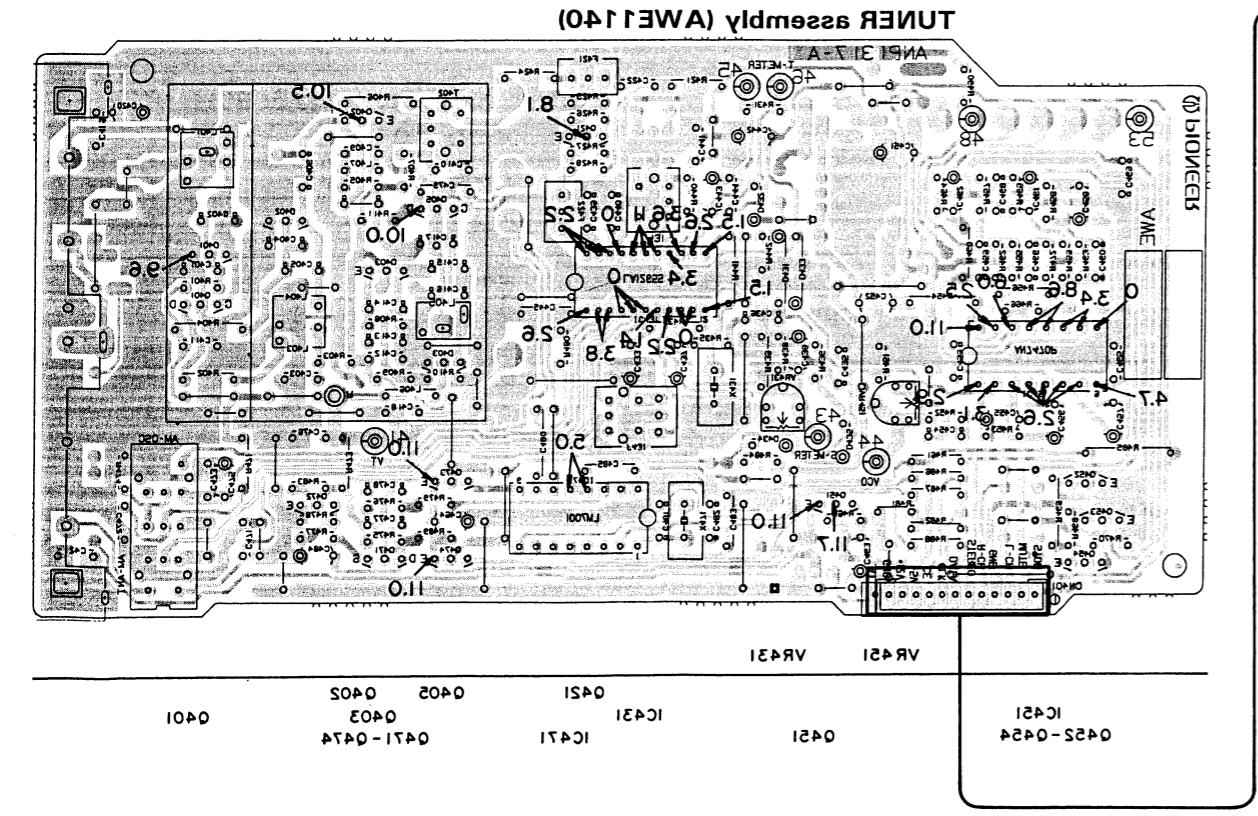

15

11

10

9

8

7

6

15

11

10

9

8

7

6

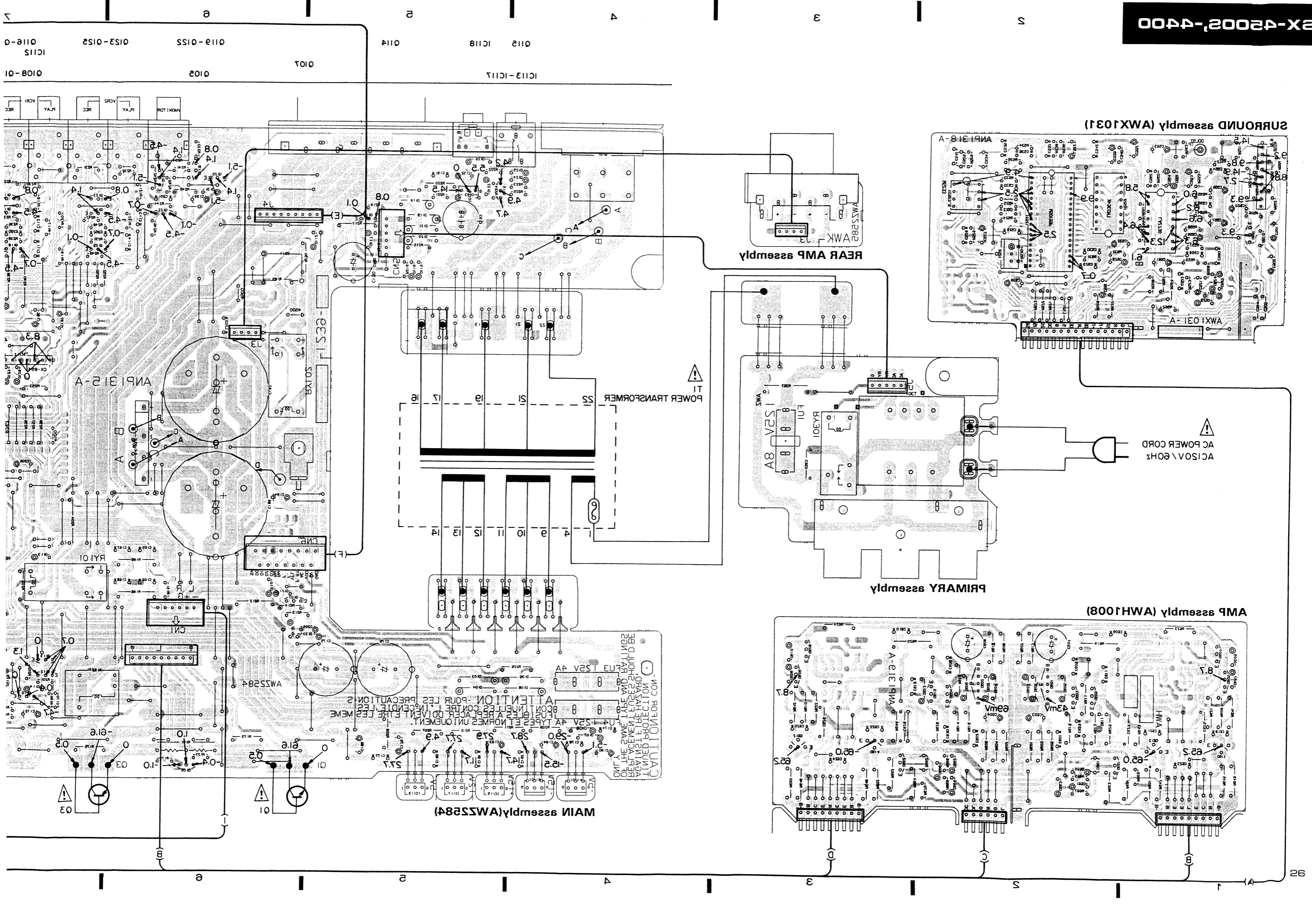
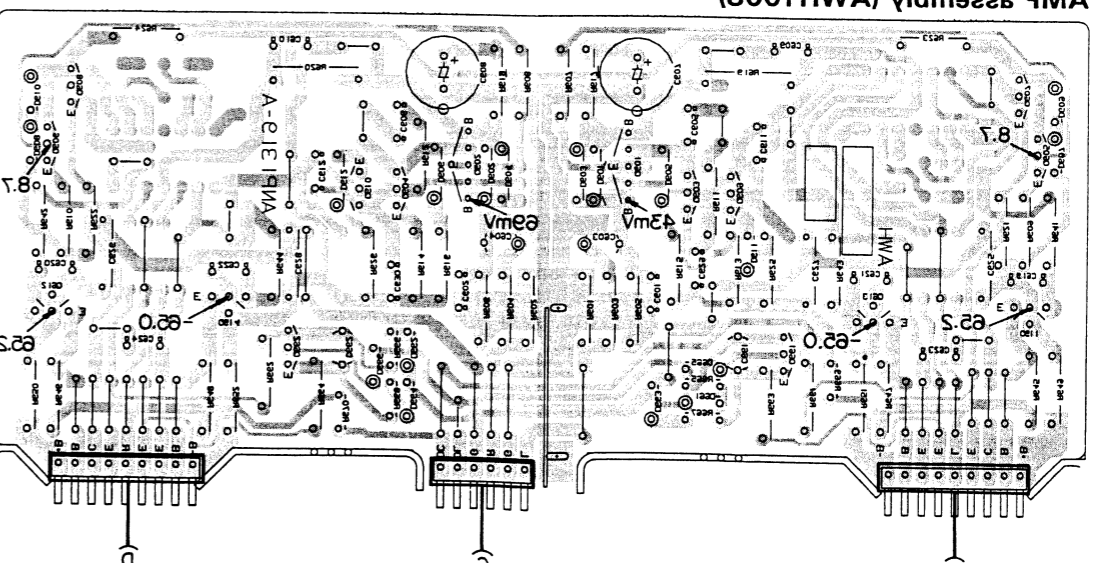
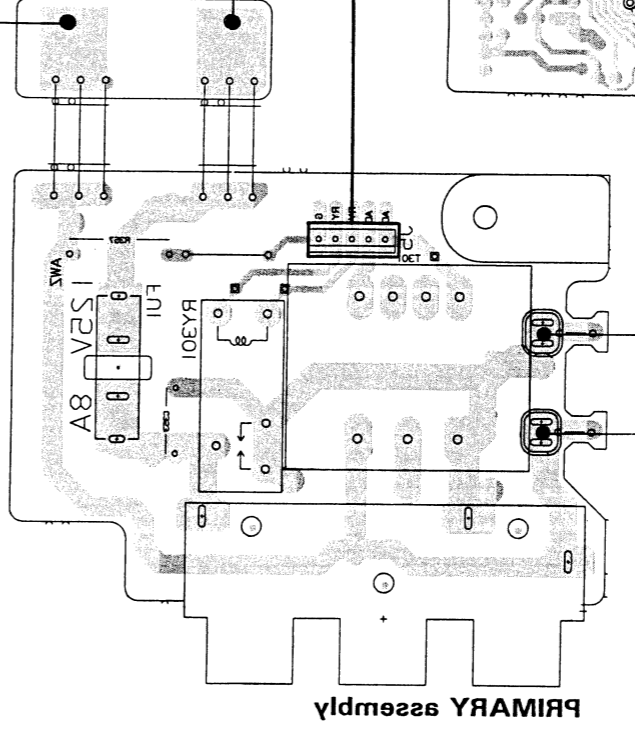
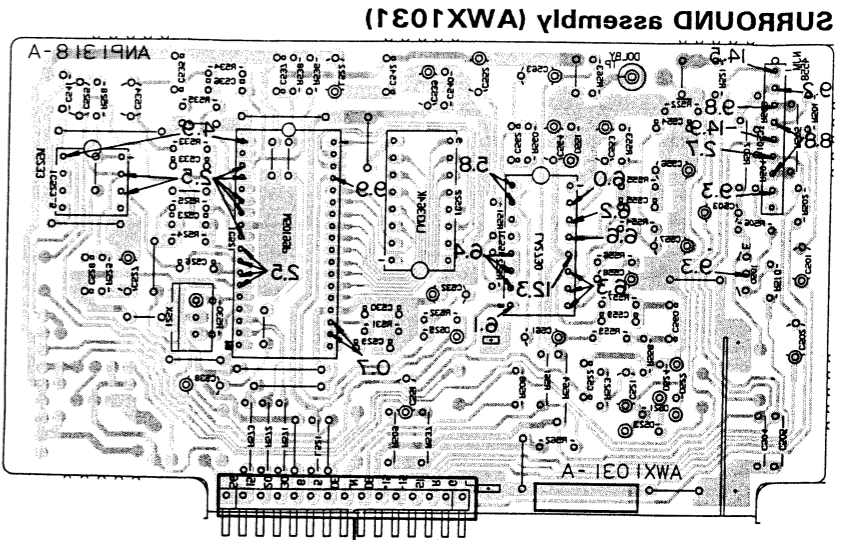
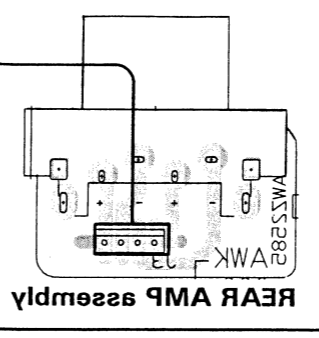
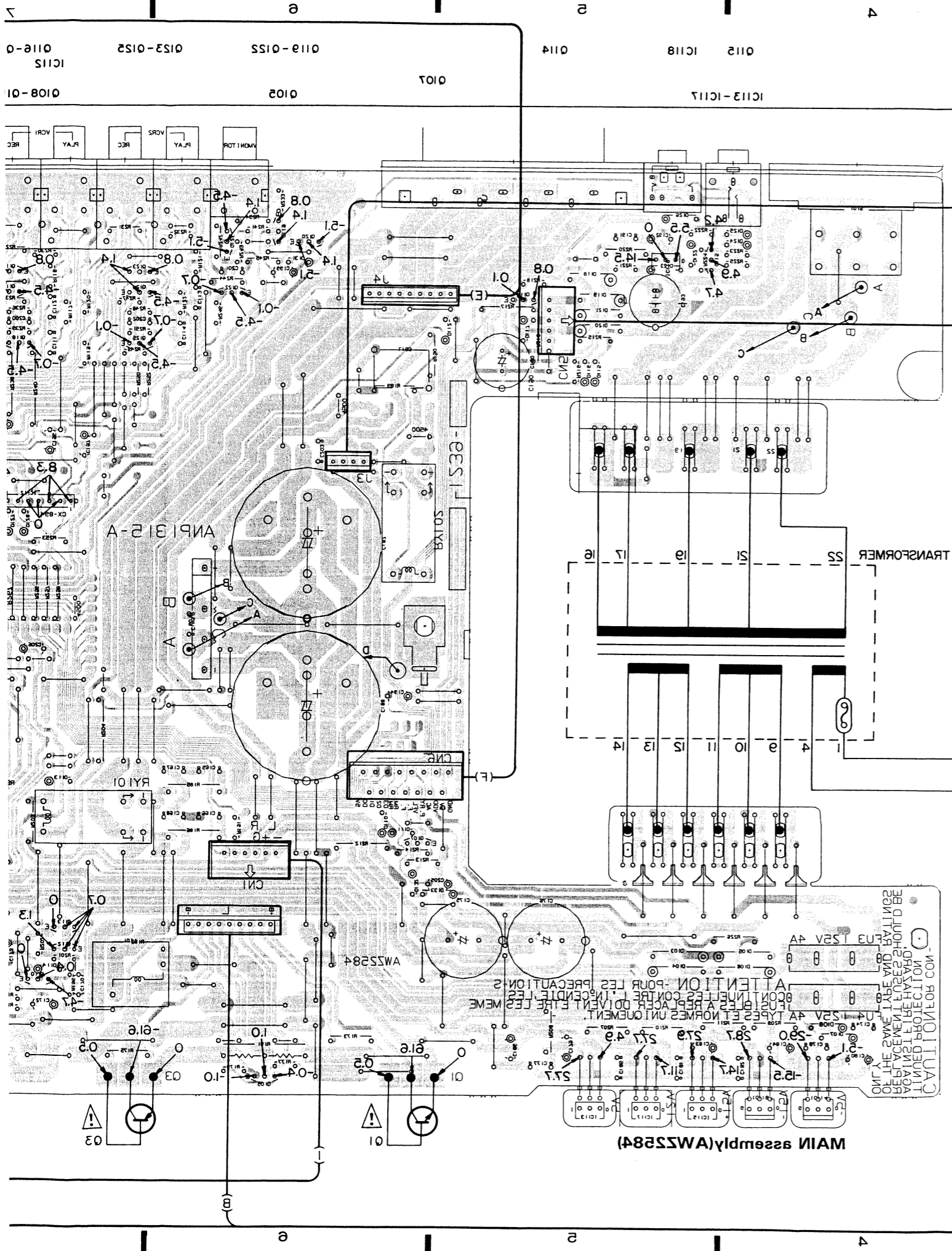

6. ELECTRICAL PARTS LIST

NOTES:

- Parts without part number cannot be supplied.
- Parts marked by "⊙" are not always kept in stock. Their delivery time may be longer than usual or they may be unavailable.
- The Δ mark found on some component parts indicates the importance of the safety factor of the part. Therefore, when replacing, be sure to use parts of identical designation.
- When ordering resistors, first convert resistance values into code form as shown in the following examples.

Ex. 1 When there are 2 effective digits (any digit apart from 0), such as 560 ohm and 47k ohm (tolerance is shown by J = 5%, and K = 10%).

560Ω 56 × 10¹ 561..... RD1/4PS ⊕ ⊕ J
 47kΩ 47 × 10³ 473..... RD1/4PS ⊕ ⊕ J
 0.5Ω 0R5..... RN2H ⊕ ⊕ K
 1Ω 010..... RS1P ⊕ ⊕ K

Ex. 2 When there are 3 effective digits (such as in high precision metal film resistors).

5.62kΩ 562 × 10¹ 5621..... RN1/4SR ⊕ ⊕ F

Miscellaneous parts

P.C.BOARD ASSEMBLIES

Mark	Symbol & Description	Part No.
	TUNER assembly	AWE1140
	SP.SW assembly	
	MAIN assembly	AWZ2584
	REAR SP assembly	
	EQ assembly	
	FRONT assembly	AWZ2587
	VOLUME assembly	
	REAR AMP assembly	
	PRIMARY assembly	

OTHERS

Mark	Symbol & Description	Part No.
Δ	Q5 Transistor	2SA1263N
Δ	Q4,Q3 Transistor	2SA1302
Δ	Q6 Transistor	2SC3180N
Δ	Q2,Q1	2SC3281
Δ	T1 Power transformer(AC120V)	ATS1215
Δ	FU3,FU4 Fuse (4A/125V)	AEK-125
Δ	FU1 Fuse (8A/125V)	AEK1002
Δ	AC Power cord	ADG1057

TUNER assembly (AWE1140)

SEMICONDUCTORS

Mark	Symbol & Description	Part No.
	IC451	AN7470P
	IC431	LA1265S
	IC471	LM7001
	Q473,Q474	RN2201
	Q454	2SA933S

Mark	Symbol & Description	Part No.
	Q452,Q453	2SC1740S
	Q472	2SC1740SLN
	Q451	2SC2603
	Q403,Q421	2SC2668
	Q402	2SC2786
	Q405	2SK161
	Q401	2SK241
	Q471	2SK246
	D431-D435	1SS252
	D401-D403	1SV147

COILS & TRANSFORMER

Mark	Symbol & Description	Part No.
	L401 FM coil	ATC1001
	L402 FM coil	ATC1002
	L405 FM coil	ATC1003
	L403 FM coil	ATC1004
	L404 FM coil	ATC1005
	L431 FM Detecor coil	ATE-079
	L406,L407 Axial inductor (2.2μH)	LAU2R2M
	F421 FM Ceramic filter	ATF-107
	F422 FM Ceramic filter	ATF-119
	F431 AM Ceramic filter	ATF-208
	T402 FM Matching transformer	ATE-063

CAPACITORS

Mark	Symbol & Description	Part No.
	C454 (470p)	ACE1039
	C445 (47p)	ACG1016
	C409,C483 (100p)	ACG1017
	C444 (330p)	ACG1018

Mark	Symbol & Description	Part No.
	C403,C410-C412,C418,C419, C421,C422,C465,C471,C473, C476,C480,C485 (0.01μF/16V) C441,C472 (0.022μF/25V) C479 (22p)	ACG1021 ACG1022 ACG1025
	C466	CCCSL121J50
	C417	CCDCH010C50
	C406	CCDCH020C50
	C415	CCDCH080D50
	C413,C481,C482	CCDCH150J50
	C414	CCDCH330J50
	C401,C404,C405	CCDRH330J50
	C402	CCDRH390J50
	C416	CCDTH180J50
	C452	CEANP4R7M35
	C457	CEASR22M50
	C442	CEASOR1M50
	C456	CEAS1R5M50
	C420,C437,C475	CEAS100M50
	C451	CEAS101M16
	C438	CEAS2R2M50
	C443,C455	CEAS3R3M50
	C433,C461,C462	CEAS4R7M50
	C458,C463,C464,C484	CEAS470M16
	C478	CFTXA224J50
	C477	CKCYF103Z50
	C439,C440	CKCYF223Z50
	C435	CKCYF472Z50
	C453	CKCYF473Z50
	C436	CKCYX683M25
	C400	CKDYF102Z50
	C459,C460	CQMA152J50
	C468,C469	CQMA182J50

RESISTORS

Mark	Symbol & Description	Part No.
	VR451 (4.7k)	ACP1024
	VR431 (10k)	ACP1025
	Other resistors	RD1/8PM□□□J

OTHERS

Mark	Symbol & Description	Part No.
	X471 Crystal resonator	ASS1005
	X431 Ceramic resonator	ATF-125
	4P Antenna terminal	AKA1014
	AM RF Tuning block	AXX1011

SP.SW assembly

SWITCH

Mark	Symbol & Description	Part No.
	S102 Push switch (SP A,SP B,REAR)	SUL6LXXXS

RESISTORS

Mark	Symbol & Description	Part No.
	R187,R188	RS2LMF331J

OTHERS

Mark	Symbol & Description	Part No.
	Head Phone jack	AKN1002

MAIN assembly(AWZ2584)

SEMICONDUCTORS

Mark	Symbol & Description	Part No.
	IC106	BU4066BL
	IC112	CX-894
	IC113	M5F78M05L
	IC117	M5F78M12L
	IC115	M5F78M15L
	IC114	M5F79M05L
	IC116	M5F79M15L
	IC109,IC110	M5220L
	IC118	M5278L56(A)
	IC108,IC111	NJM4558S-X
	IC107	TC4028BP
	IC103,IC105	TC9154AP
	IC101,IC102	TC9164N
	IC104	TC9184P
	Q101,Q103,Q120	RN1203
	Q102,Q104	RN2203
	Q111,Q118,Q122,Q125	2SA1048
	Q107-Q110,Q112-Q117,Q119, Q121,Q123,Q124,Q126-Q128	2SC2458
	Q105,Q106	2SC2603

Mark	Symbol & Description	Part No.
	D109	D5SB20F
	D114 Zener diode	HZS9AL
	D101,D102,D116,D133	RD5.1ESB2
	Zener diode	
	D118-D121	1SR139-400

Mark	Symbol & Description	Part No.
	D110-D113,D115,D117,D122, D124-D128,D131,D132,D134, D135	1SS252
	D123	1S1555
	D107,D108	1S2471
	D103-D106	10E2FD

SWITCH & RELAIIES

Mark	Symbol & Description	Part No.
	S101 Line voltage selector switch	AKX1033
	RY101 Relay	ASR-112
	RY102 Relay	ASR1005

COILS

Mark	Symbol & Description
	L101,L102
	L103 AF Ch

CAPACITORS

Mark	Symbol & Description
	C174,C189 (C)
	C175,C176 (C)
	C193 (47000)
	C187,C188 (C)
	C200-C202

Mark	Symbol & Description
	C101-C106,
	C107,C108
	C137,C138
	C170
	C139,C140,C

Mark	Symbol & Description
	C143,C144
	C173,C204
	C135,C136,C
	C199
	C129-C134,

Mark	Symbol & Description
	C162,C163,C
	C194-C197
	C158,C159,C
	C172
	C205
	C180,C206

Mark	Symbol & Description
	C190
	C169
	C165-C168
	C147-C150
	C203

Mark	Symbol & Description
	C145,C146
	C191,C208,C
	C171,C177,C
	C182,C185
	C141,C142
	C160

RESISTORS

Mark	Symbol & Description
	R181,R182 (O)
	R183-R186
	R226,R203
	R173-R176,F
	R204,R207-F

Other resistors

OTHERS

Mark	Symbol & Description
	2P Terminal (C)
	4P Terminal (T, POWER IN,
	3P Terminal (V
	2P Terminal (V

COILS

Mark	Symbol & Description	Part No.
J	L101,L102 AF Choke coil (0.7μH)	ATH1004
	L103 AF Choke coil (0.7μH)	ATH1011

CAPACITORS

Mark	Symbol & Description	Part No.
	C174,C189 (0.01μF)	ACG1005
	C175,C176 (4700μF/35V)	ACH1021
	C193 (47000μF/5.5V)	ACH1070
	C187,C188 (8200μF/71V)	ACH1074
	C200-C202	CCMSL080D50

C101-C106,C109-C114	CCMSL101J50
C107,C108	CCMSL680J50
C137,C138	CCMSL820J50
C170	CEANP4R7M50
C139,C140,C161,C164	CEAS010M50

C143,C144	CEAS100M25
C173,C204	CEAS101M16
C135,C136,C157,C207,C210	CEAS2R2M50
C199	CEAS220M25
C129-C134,C151-C156,C198	CEAS4R7M50

C162,C163,C179,C192, C194-C197	CEAS470M10
C158,C159,C183,C184,C186 C172	CEAS470M16
C205	CEAS470M35
C180,C206	CEAS470M50

C190	CEAS471M25
C169	CEAS471M6
C165-C168	CFTXA104J50
C147-C150	CFTXA153J50
C203	CFTXA473J50
C145,C146	CFTXA823J50
C191,C208,C209	CKCYF103Z50
C171,C177,C178,C181, C182,C185	CKCYF473Z50
C141,C142	CQMA272K50
C160	CKDYX473M16

RESISTORS

Mark	Symbol & Description	Part No.
	R181,R182 (0.33 × 2 (5W))	ACN-139
	R183-R186	RS1LMF100J
	R226,R203	RFA1/4PS□□□J
	R173-R176,R189,R190,R204, R204,R207-R212,R219,R220	RD1/4PMF□□□J

Other resistors	RD1/8PM□□□J
-----------------	-------------

OTHERS

Mark	Symbol & Description	Part No.
	2P Terminal (CD)	AKB1100
	4P Terminal (TAPE 1, TAPE 2, POWER IN, PRE OUT)	AKB1101
	3P Terminal (VDP, VCR 1, VCR 2)	AKB1102
	2P Terminal (V MONITOR)	AKB1103

Mark	Symbol & Description	Part No.
	8P Terminal (SPEAKER)	AKE-111

2P Mini jack (REMOTE CONTROL)	AKN1006
Mini jack (MULTI ROOM)	AKN1020

CN2 3P Jumper connector	KPC3
CN5 5P Jumper connector	KPC5
CN1 6P Jumper connector	KPC6
CN6,CN7 15P Jumper connector	KPE15

AMP assembly	AWH1008
SURROUND assembly	AWX1031

AMP assembly (AWH1008)

Note:
This AMP assembly (AWH1008) is a part of MAIN asdsembly (AWZ2584).

SEMICONDUCTORS

Mark	Symbol & Description	Part No.
	Q607,Q608	2SA1145
	Q613,Q614	2SA1306
	Q605,Q606	2SA970
	Q601,Q602	2SA979
	Q603,Q604,Q661,Q662	2SC2240

Q609,Q610	2SC2705
Q611,Q612	2SC3298

D601-D612,D661-D666	1SS252
---------------------	--------

CAPACITORS

Mark	Symbol & Description	Part No.
	C625-C628 (0.047μF/125V)	ACG-009
	C611,C612	CCCSL020C500
	C629,C630	CCCSL101J50
	C619-C622	CCCSL101K500
	C661,C662	CEANP2R2M100

C603,C604	CEAS2R2M50
C607,C608	CEXA471M16
C605,C606	CKCYB122K50
C623,C624	CKCYX473M25
C609,C610	CMA100D500
C601,C602	CQMA102J50

RESISTORS

Mark	Symbol & Description	Part No.
	R619,R620	RDR1/2PM123J
	R605,R606,R617,R618	RDR1/4PM□□□J
	R641-R648,R661-R664	RD1/4PMF□□□J
	R665-R670	RD1/8PM□□□J

R613-R616,R621,R622,R625, R626,R649-R652	RFA1/4PS□□□J
---	--------------

Other resistors	RD1/4PM□□□J
-----------------	-------------

SURROUND assembly (AWX1031)

Note:
This SURROUND assembly (AWX1031) is a part of MAIN asdsembly (AWZ2584).

SEMICONDUCTORS

Mark	Symbol & Description	Part No.
	IC551	LA2730
	IC522	LM3364K-15
	IC521	M50199P
	IC523	M5233P
	IC501	NJM4558S-X

Q501	2SC1740S
------	----------

D551 Zener diode	RD12ESB
D521-D525	1SS252

COILS

Mark	Symbol & Description	Part No.
	L521 Axial inductor (2.2μH)	LAU2R2M
	L522 inductor (8.2mH)	LTA822J

CAPACITORS

Mark	Symbol & Description	Part No.
	C504,C505,C540,C541 (0.01μF/125V)	ACG1021
	C534	CEANP010M50
	C525	CEANP4R7M35
	C553	CEASR33M50
	C556	CEAS010M50

C552	CEAS100M50
C539,C558	CEAS101M10
C557,C561	CEAS220M16
C501-C503,C521,C538, C551,C563	CEAS4R7M50

C527,C532	CEAS470M10
C564	CEAS470M25
C528	CFTXA103J50
C526,C533,C554	CFTXA104J50
C555,C560	CFTXA333J50

C529,C530	CFTXA823J50
C562	CKMYB471K50
C542	CQMA183J50
C559	CQMA472J50
C522,C535,C537	CQMA562J50

C523,C536	CQSA561J50
-----------	------------

RESISTORS

Mark	Symbol & Description	Part No.
	All resistors	RD1/8PM□□□J

OTHER

Mark	Symbol & Description	Part No.
	X521 Ceramic resonator	ASS1016

REAR SP assembly

OTHERS

Mark	Symbol & Description	Part No.
	4P Terminal (SPEAKER)	AKE1012

EQ assembly

SEMICONDUCTORS

Mark	Symbol & Description	Part No.
	IC332	M5218P

CAPACITORS

Mark	Symbol & Description	Part No.
	C331,C332	CCCSL221J50
	C343	CCMSL150J50
	C329,C330	CEAS100M50
	C339,C340	CEAS2R2M50
	C333,C334	CEAS470M10

C341,C342,C354	CKCYF473Z50
C335,C336	CQMA242J50
C337,C338	CQMA822J50

RESISTORS

Mark	Symbol & Description	Part No.
	VR301 (250k)	ACS1038
	Other resistors	RD1/8PM□□□J

OTHER

Mark	Symbol & Description	Part No.
	2P Terminal	AKB1099

FRONT assembly (AWZ2587)

SEMICONDUCTORS

Mark	Symbol & Description	Part No.
	IC301	PDG043

Q301	RN1203
Q302-Q307,Q313,Q314	2SC2458

D301	S5566
D302-D317	1SS252

SWITCHES

Mark	Symbol & Description	Part No.
	S304,S339 Tact switch	ASG-703
	S301-S303,S305-S338, S340-S351 Tact switch	ASG1029

COIL

Mark	Symbol & Description	Part No.
	L301 Axial inductor (10μH)	LAU100K

CAPACITORS

Mark	Symbol & Description	Part No.
	C301	CEJAOR1M50
	C302-C304	CEJA100M16
	C305	CEJA220M6

RESISTORS

Mark	Symbol & Description	Part No.
	All resistors	RD1/8PM□□□J

OTHERS

Mark	Symbol & Description	Part No.
	X301 Ceramic resonator	ASS1022
	V301 Fluorescent indicator tube	AAV1081
	Remote control sensor unit	AXX1010

**VOLUME assembly
SEMICONDUCTORS**

Mark	Symbol & Description	Part No.
	IC323	M5220L
	IC324	TA7291S
	Q323	RN1203

CAPACITORS

Mark	Symbol & Description	Part No.
	C352	CEANP2R2M50
	C347,C348	CEAS4R7M50
	C351	CEAS470M16
	C345,C346	CKCYB103K50
	C349,C350	CKCYB331K50

RESISTORS

Mark	Symbol & Description	Part No.
	VR302 (100k × 4, 50k × 3)	ACX1033
	R353	RD1/4PMF2R2J
	Other resistors	RD1/8PM□□□J

OTHERS

Mark	Symbol & Description	Part No.
	CN8 3P Jumper connector	KPE3

**REAR AMP assembly
SEMICONDUCTORS**

Mark	Symbol & Description	Part No.
	IC321	UPC1270H
	Q322	2SC2240
	Q321	2SC2458

Mark	Symbol & Description	Part No.
	D322,D323	1SS252
	D321	1S2471

CAPACITORS

Mark	Symbol & Description	Part No.
	C324	CCCSSL270J50
	C328	CEANP2R2M50
	C323	CEAS101M10
	C321	CEAS2R2M50
	C322	CKCYB102K50
	C326,C327	CKDYF473Z50
	C325	CQMA333K50

RESISTORS

Mark	Symbol & Description	Part No.
	R329 (0.22 × 2)	ACN-131
	Other resistors	RD1/8PM□□□J

**PRIMARY assembly
RELAY**

Mark	Symbol & Description	Part No.
⚠	RY301	ASR1027

TRANSFORMER

Mark	Symbol & Description	Part No.
⚠	T301 Power transformer	ATT1011

CAPACITOR

Mark	Symbol & Description	Part No.
⚠	C353 (0.01μF/125V)	ACG10O2

RESISTOR

Mark	Symbol & Description	Part No.
⚠	R357 (2.2M)	ACN-209

OTHER

Mark	Symbol & Description	Part No.
⚠	3P AC Outlet	AKP104-1

7. ADJUSTMENTS

7.1 TUNER SECTION

1. Wiring Connect the wires as shown in Fig.1 (FM ANT. terminal: 75Ω).
2. Preset Set the VR451 to center position.

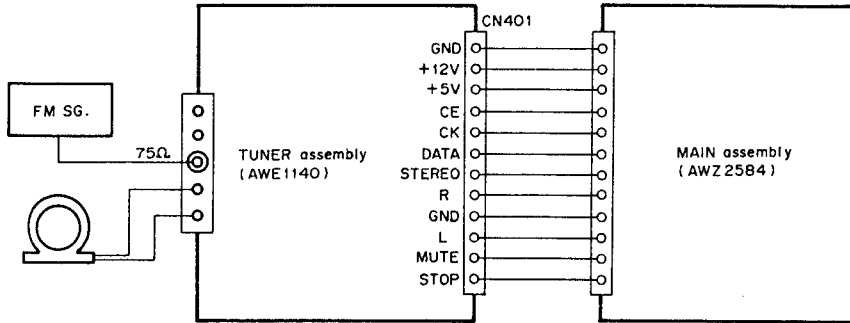

Note: Stereo modulation: Main 1kHz L+R ±68.25kHz
Pilot 19 kHz ±6.75kHz

FM Section

Order	Item	SSG			Receiving frequency	Adjustment	
		Frequency	Modulation	Level		Adjustment location	Remarks
1	Checking front end VT	No signal			108MHz	—	Check that the voltage between terminal 41 and ground is 8.7 ±2.0V.
2	Checking front end VT	No signal			87.5MHz	—	Check that the voltage between terminal 41 and ground is 3.4 ±1.5V.
3	Increasing front end sensitivity	98MHz		Weak input	98MHz	L402, L404, T402	Set the voltage between terminal 43 and ground to maximum, and check that the practical sensitivity is as specified.
4	Center adjustment	98MHz		60dBμV	98MHz	L431	Adjust the voltage between terminals 45 and 46 to 0 ±50mV.
5	Checking monophonic distortion	98MHz	1kHz ±75kHz dev.	60dBμV	98MHz	—	Check that the monophonic distortion is as specified.
6	Adjusting VCO		OFF	60dBμV		VR451	Adjust the output of terminal 44 to 76.0kHz ±1.0kHz.
7	Adjusting stereo distortion	98MHz	L—ONLY R—ONLY	60dBμV	98MHz	T402	Minimize the distortion within 1/4 rotation of the core, and check conformity to the specification.
8	Checking separation	98MHz	L—ONLY R—ONLY	60dBμV	98MHz	—	Check that the separation of L→R and R→L is as specified.
9	Checking lighting levels of TUNED and STEREO IND.	98MHz	STEREO		98MHz	—	Check that the lighting levels of TUNED and STEREO IND. are as Specified.

AM Section

Order	Item	SSG			Receiving frequency	Adjustment	
		Frequency	Modulation	Level		Adjustment location	Remarks
1	Checking front end VT	No signal			1700kHz	—	Check that the voltage between terminal 41 and ground is $7.5 \pm 1.0V$.
2	Checking front end VT	No signal			530kHz	—	Check that the voltage between terminal 41 and ground is $1.5 \pm 0.5V$.
3	Checking front end sensitivity	1000kHz	400 Hz 30% MOD.	Practical sensitivity level	1000kHz	—	Check that the practical sensitivity (maximum sensitivity) is as specified.
4	Adjusting lighting level of TUNED IND.	1000kHz			1000kHz	VR431	Adjust the lighting level of TUNED IND. to $55dB\mu V/m \pm 3dB$.

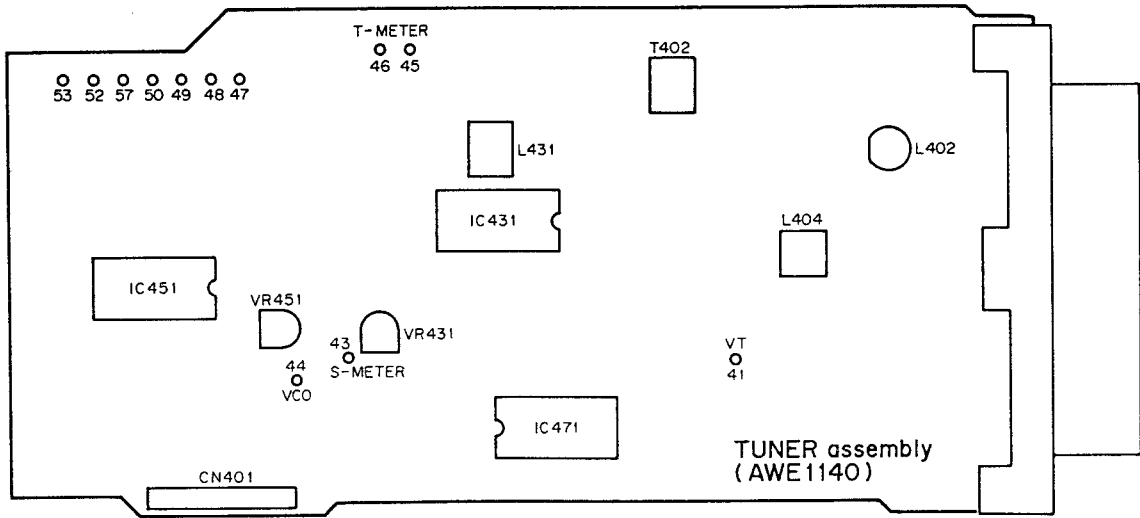

VSX-4500S,-4400

FLUORESCENT INDICATOR TUBE (AAV1081)

Outer dimension

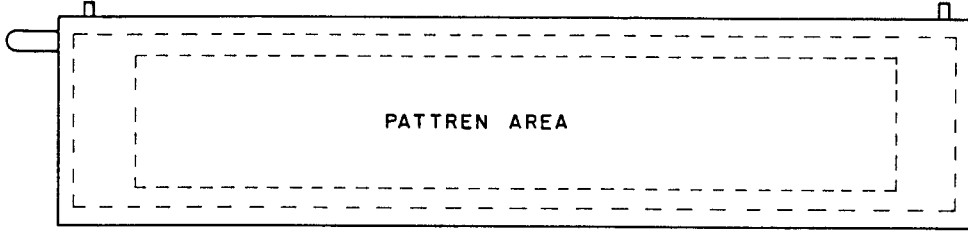

Grid assignment

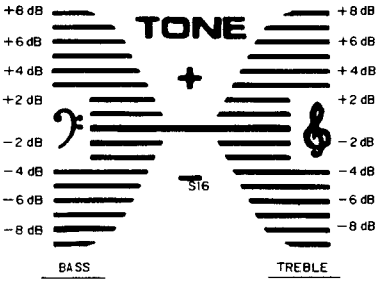
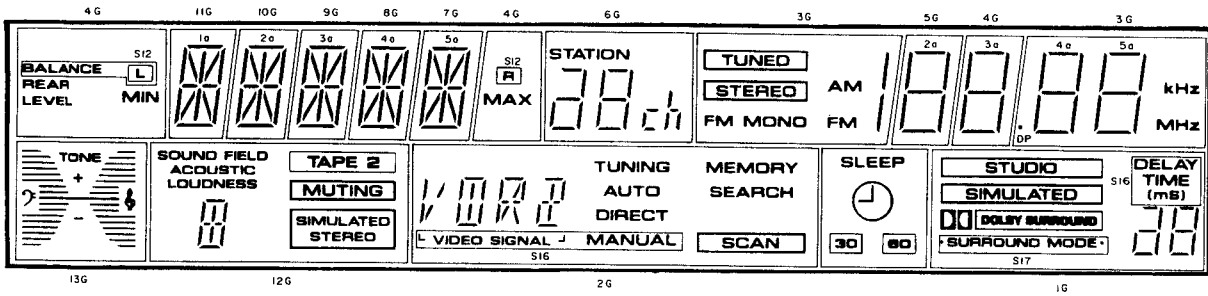

13G



7G~11G AL-XX

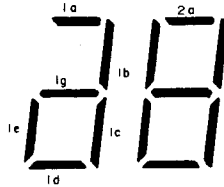

6G ST-XX

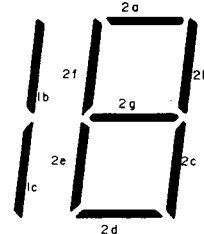

3G~5G Fr-XX



12G AC-XX

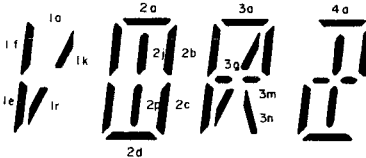

2G VIDEO-XX

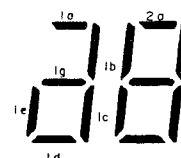

1G DE-XX

Pin connection

PIN NO.	65	64	63	62	61	60	59	58	57	56	55	54	53	52	51	50	49	48	47	46	45	44	43	42	41	40	39	38	37	36	35	34	33	32	
CONNECTION	F2	F2	F2	N	N	N	N	N	N	N	N	N	N	N	N	N	N	N	N	N	N	N	N	N	N	N	N	S	S	S	S	S	S	N	S

PIN NO.	31	30	29	28	27	26	25	24	23	22	21	20	19	18	17	16	15	14	13	12	11	10	9	8	7	6	5	4	3	2	1
CONNECTION	S	S	S	S	S	S	S	S	S	S	S	N	13	G	G	G	G	G	G	G	G	G	G	G	G	G	G	F1	F1	F1	

8. IC INFORMATION

<PDG043> SYSTEM CONTROL MICROCOMPUTER

- Pin connections (Top view)

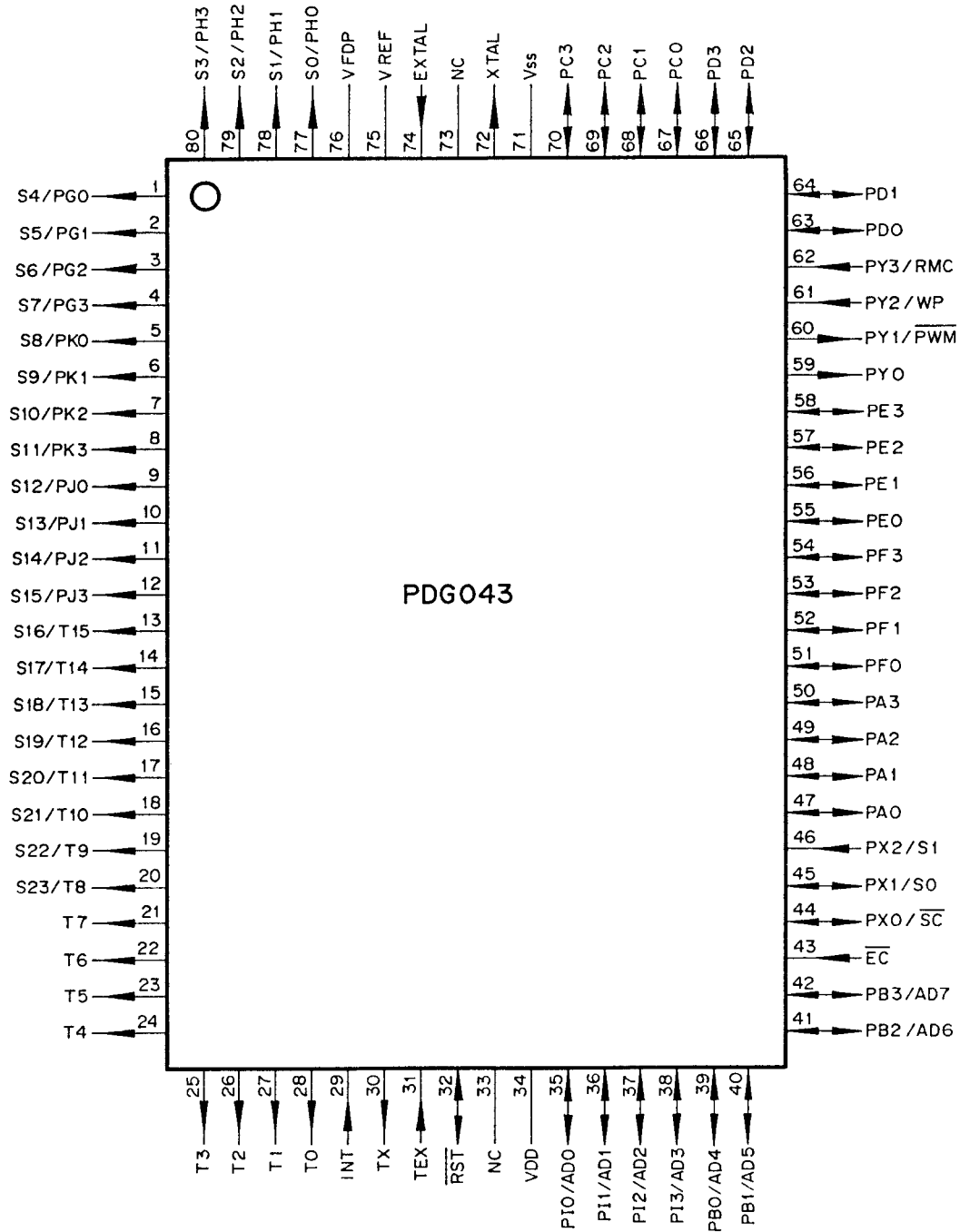

• PDG043 Terminal Functions

Pin No.	Terminal name	I/O	Function	Active
1	S4/PG0	O	FL segment output	H
2	S5/PG1	O		H
3	S6/PG2	O		H
4	S7/PG3	O		H
5	S8/PK0	O		H
6	S9/PK1	O		H
7	S10/PK2	O		H
8	S11/PK3	O		H
9	S12/PJ0	O		H
10	S13/PJ1	O		H
11	S14/PJ2	O		H
12	S15/PJ3	O		H
13	S16/T15	O	FL timing output	H
14	S17/T14	O		H
15	S18/T13	O		H
16	S19/T12	O		H
17	S20/T11	O		H
18	S21/T10	O		H
19	S22/T9	O		H
20	S23/T8	O		H
21	T7	O		H
22	T6	O		H
23	T5	O		H
24	T4	O		H
25	T3	O		H
26	T2	O		H
27	T1	O		H
28	T0	O	H	
29	INT	I	Version change	
30	TX	O	Unused	
31	TEX	I	Unused Connected to GND or VDD	
32	RST	I/O	Reset input	L
33	NC		Unused	
34	VDD		+5V	
35	PI0/AD0	I/O	Level meter input (FRONT L)	
36	PI1/AD1	I/O	Level meter input (FRONT R)	
37	PI2/AD2	I/O	Level meter input (REAR L)	
38	PI3/AD3	I/O	Level meter input (REAR R or CENTER)	
39	PB0/AD4	I/O	Unused	
40	PB1/AD5	I/O	Surround mode control 1	H
41	PB2/AD6	I/O	Surround mode control 2	
42	PB3/AD7	I/O	Surround mode control 3	

Pin No.	Terminal name	I/O	Function	Active
43	EC	I	Unused	
44	PX0/SC	I/O	J/EX or serial clock output	
45	PX1/SO	I/O	ch STEP 0k,50k/10k,100k or serial data output	
46	PX2/SI	I	Stereo	L
47	PA0	I/O	Tuner mute	H
48	PA1	I/O	Stop (TUNED)	L
49	PA2	I/O	Key scan (INPUT)	H
50	PA3	I/O	Version change	
51	PF0	I/O	TC4023 Control signal	
52	PF1	I/O	TC4023 Control signal	
53	PF2	I/O	Surround mode control 4	
54	PF3	I/O	TC4023 Control signal	
55	PE0	I/O		H
56	PE1	I/O	Key scan input	H
57	PE2	I/O		H
58	PE3	I/O		H
59	PY0	O	TV Antenna ON/OFF	H
60	PY1/PWM	O	VIDEO ENHANCER ON/OFF	H
61	PY2/WP	I	WP Input Input to AC50Hz or AC60Hz	H
62	PY3/RMC	I	Remote control signal input	L
63	PD0	I/O	VIDEO MUTE	H
64	PD1	I/O		
65	PD2	I/O	VIDEO Control	
66	PD3	I/O		
67	PC0	I/O	VOLUME IND.	H
68	PC1	I/O	VOLUME CONTROL DOWN	L
69	PC2	I/O	VOLUME CONTROL UP	L
70	PC3	I/O	AC (POWER) RY ON/OFF	H
71	Vss		Connected to GND	
72	XTAL	O	MAIN CLOCK output Connected to 4.19MHZ ceramic resonator	
73	NC		Unused	
74	EXTAL	I	MAIN CLOCK input Connected to 4.19MHZ ceramic resonator	
75	VREF		Reference voltage input Connected to VDD	
76	VFDP		Power terminal for FL	
77	S0/PH0	O		H
78	S1/PH1	O	Segment output for FL	H
79	S2/PH2	O		H
80	S3/PH3	O		H

9. REMOTE CONTROL UNIT (AXD1104)

9.1 EXPLODED VIEWS AND PARTS LIST

Parts list of remote control unit

Mark	No.	Parts No.	Description
	1	AZH1033	Case(A)
	2	AZH1034	Case(B)
	3	AZH1035	Case(C)
	4	AZN1400	Filter
	5	AZA1204	Rubber sheet
	6	AZS1042	Knob
	7	AZA1203	Name plate
	8	AZB1124	Screw
	9	AZN1401	Leg
	10	AZB1274	Electrode spring
	11	AZB1275	Electrode spring
	12	AZB1276	Electrode spring
	13	AZB1277	Electrode spring
	14	AAK1439	Sheet
	15	AZA1191	Label

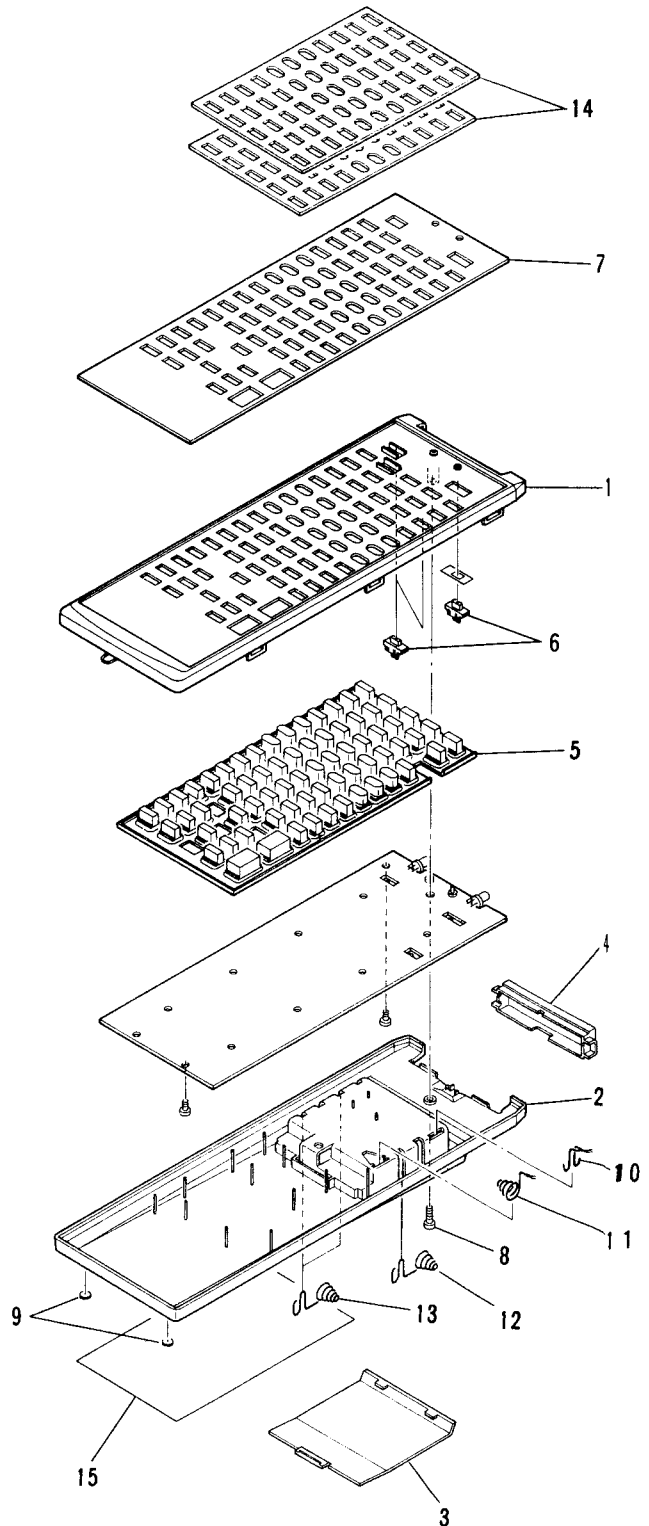

9.2 ELECTRICAL PARTS LIST

NOTES:

- Parts without part number cannot be supplied.
- Parts marked by “●” are not always kept in stock. Their delivery time may be longer than usual or they may be unavailable.
- The △ mark found on some component parts indicates the importance of the safety factor of the part. Therefore, when replacing, be sure to use parts of identical designation.
- When ordering resistors, first convert resistance values into code form as shown in the following examples.

Ex. 1 When there are 2 effective digits (any digit apart from 0), such as 560 ohm and 47k ohm (tolerance is shown by J = 5%, and K = 10%).

560Ω	56×10^1	561.....	RD1/4PS	5	6	1	J
47kΩ	47×10^3	473.....	RD1/4PS	4	7	3	J
0.5Ω	0R5.....		RN2H	0	5		K
1Ω	010.....		RS1P	0	1	0	K

Ex. 2 When there are 3 effective digits (such as in high precision metal film resistors).

5.62kΩ	562×10^1	5621.....	RN1/4SR	5	6	2	1	F
--------	-------------------	-----------	---------	---	---	---	---	---

SEMICONDUCTORS

Mark	Symbol & Description	Part No.
	IC01	PD5108-A
	IC02	AZC1045
	IC03	AZC1046
	IC04	AZC1047
	IC05	AZC1048
	Q1,Q2	AZC1050
	Q3,Q4	AZC1051
	Q5	AZC1052
	D01,D02,D07-D15	AZC1233
	D03-D06	AZC1049
	PHD01	AZC1055
	LED01,LED02	AZC1054
	IED01,IED02	AZC1053

SWITCHES

Mark	Symbol & Description	Part No.
	S01,S02 Slide switch	AZC1079
	S04 Slide switch	AZC1081
	S05 Slide switch	AZC1080

CAPACITORS

Mark	Symbol & Description	Part No.
	C01 (220p)	AZC1058
	C02 (33p)	AZC1059
	C05,C06 (20p)	AZC1060
	C08 (0.01 μF)	AZC1061
	C03,C04 (0.001 μF)	AZC1062
	C11 (0.01 μF)	AZC1063
	C10 (100 μF)	AZC1251
	C07 (4.7 μF)	AZC1252
	C09 (1000 μF)	AZC1255

RESISTORS





Mark	Symbol & Description	Part No.
	R01 (8.2k)	AZC1064
	R02 (4.7k)	AZC1065
	R03,R08 (33k)	AZC1066
	R05,R17 (10k)	AZC1068
	R06 (82k)	AZC1069
	R09 (6.8k)	AZC1070
	R10 (56k)	AZC1071
	R12 (1M)	AZC1072
	R07,R11,R30-R38 (100k)	AZC1073
	R19-R21 (2.2k)	AZC1074
	R13,R16 (680Ω)	AZC1075
	R15 (10Ω)	AZC1076
	R18,R22-R29 (47k)	AZC1077
	R14 (3.9Ω)	AZC1078
	R04 (560k)	AZC1256

OTHERS

Mark	Symbol & Description	Part No.
	X01 Resonator	AZC1057

9.3 P.C.BOARD PATTERNS

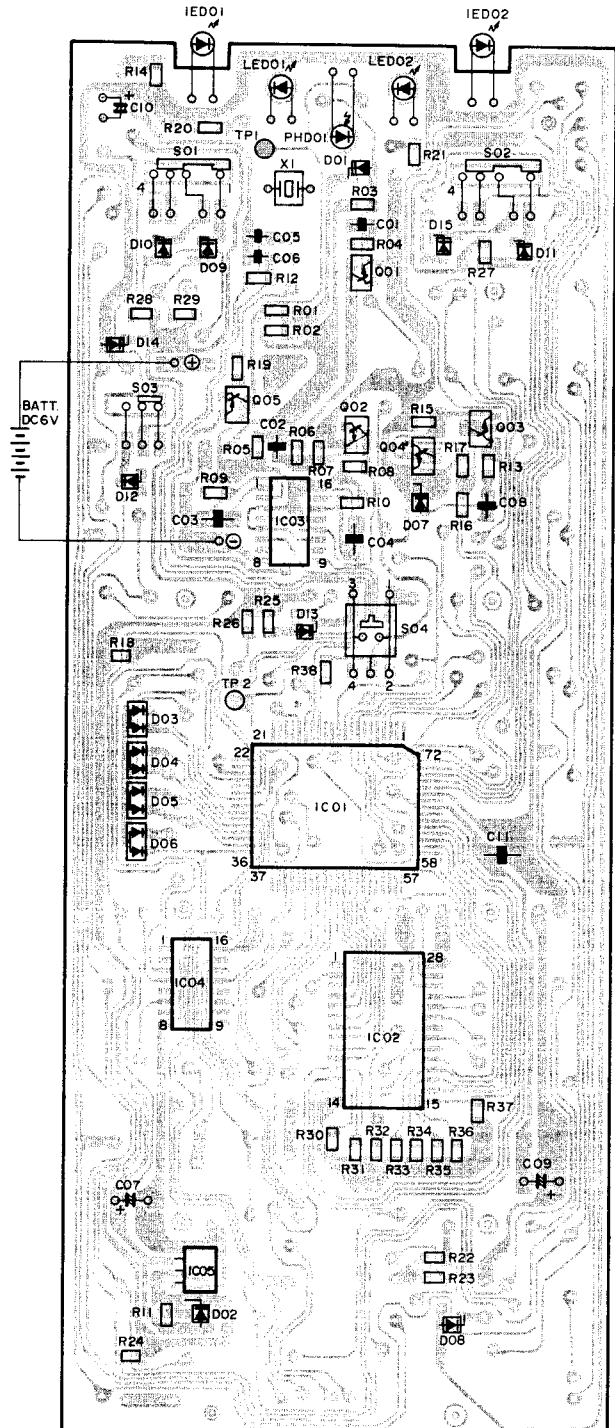
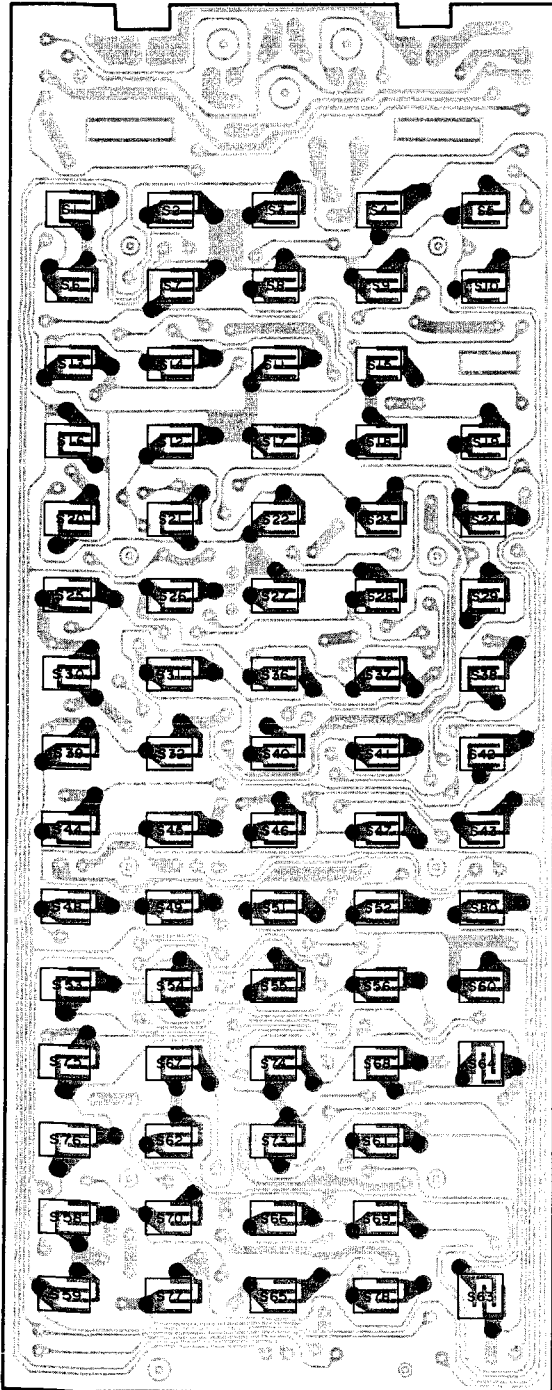

NOTE :

-  : Indicates a chip resistor.
-  : Indicates a chip capacitor.
-  : Indicates a chip transistor.
-  : Indicates a chip diode.



9.4 SCHEMATIC DIAGRAM

1. RESISTORS:
Indicated in Ω , $\frac{1}{4}W$, $\frac{1}{2}W$, $\pm 5\%$ tolerance unless otherwise noted k: k Ω , M: M Ω , (F): $\pm 1\%$, (G): $\pm 2\%$, (K): $\pm 10\%$ (M); $\pm 20\%$ tolerance
2. CAPACITORS:
Indicated in capacity (μF)/voltage (V) unless otherwise noted p: pF Indication without voltage is 50V except electrolytic capacitor.

3. OTHERS:
 : Signal route.
 : Adjusting point.
 The  mark found on some component parts indicates the importance of the safety factor of the part. Therefore, when replacing, be sure to use parts of identical designation.
 * marked capacitors and resistors have parts numbers.
- This is the basic schematic diagram, but the actual circuit may vary due to improvements in design.

The underline indicates the switch position

- S01 : AUDIO/VIDEO/AUX
- S02 : SR RECALL/USE/LEARN
- S05 : DECK I/DECK II
- S04 : RESET
- TAPE/VCR
 - S-1 : VCR POWER
 - S-2 : TAPE/VCR
 - S-3 : TAPE/VCR
 - S-4 : VCR CH-
 - S-5 : VCR CH+
 - S-6 : <
 - S-7 : </ANT/TV/VCR
 - S-8 : >
 - S-9 : >
 - S-10 : >
- CD/VDP
 - S-11 : DISC SEL/DISPLAY CALL
 - S-12 : >
 - S-13 : >
 - S-14 : >
 - S-15 : PROG
 - S-16 : <
 - S-17 : >
 - S-18 : >
 - S-19 : >
- TUNER/CD/TV/VDP
 - S-20 : 1/13
 - S-21 : 2/14
 - S-22 : 3/15
 - S-23 : 4/16
 - S-24 : 5/17
 - S-25 : 6/18
 - S-26 : 7/19
 - S-27 : 8/20
 - S-28 : 9/21
 - S-29 : 0, 10/22
 - S-30 : 11/MEMORY/23
 - S-31 : 12/CLEAR/24
- TUNER/CD/PHONO/AMP/TV
 - S-32 : BAND/DUAL

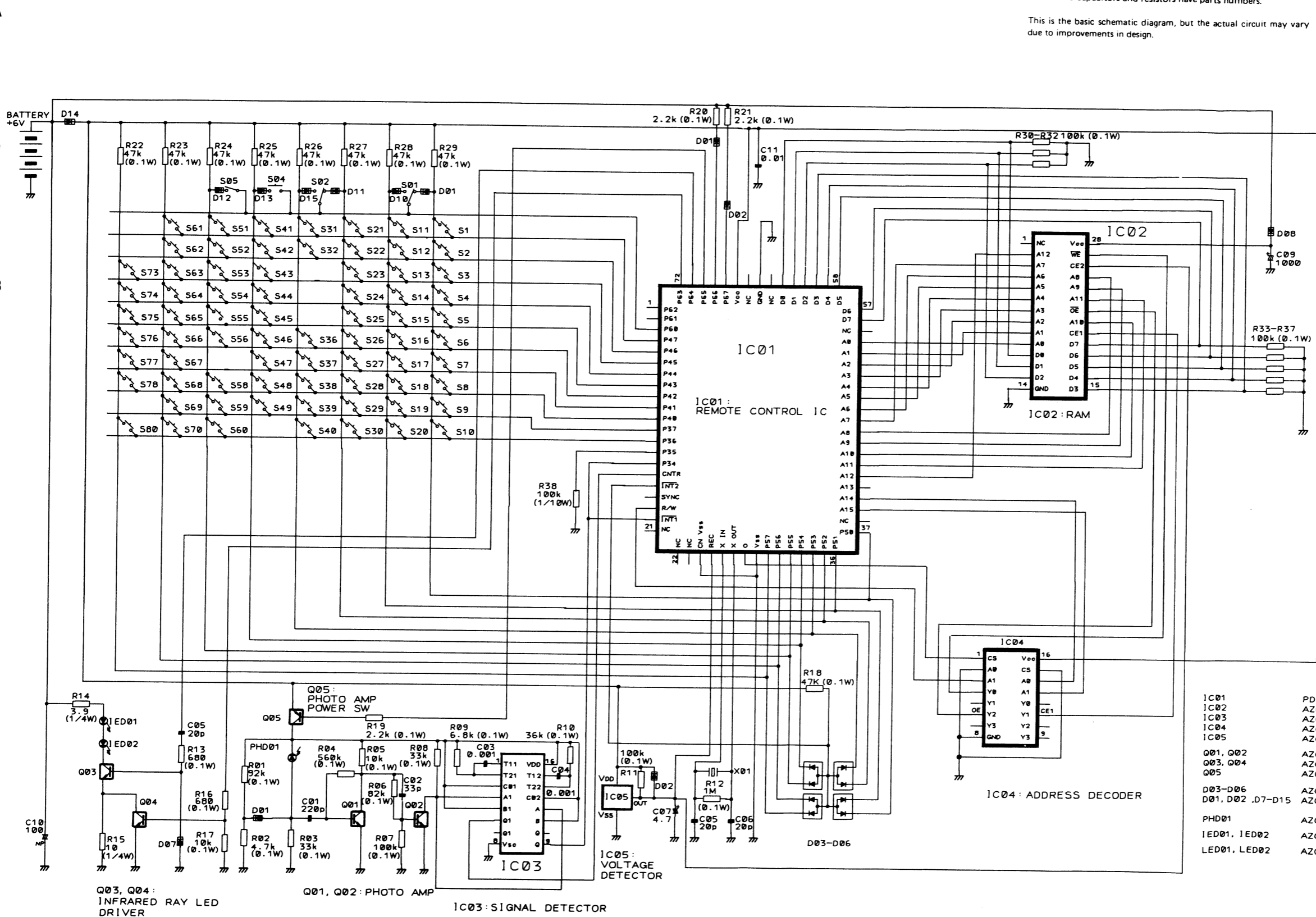

- S-36 : 1:12/13 24/CH-RETURN
- S-37 : FREQUENCY-/TV CHANNEL-
- S-38 : FREQUENCY+/TV CHANNEL+
- S-39 : TV POWER
- S-40 : CD+10/TV FUNC CYCLIC
- S-41 : PHONO >/TV VOL-
- S-42 : PHONO >/TV VOL+
- S-43 : AMP DISPLAY/TV DISPLAY
- S-44 : VCR 1
- S-45 : VCR 2
- S-46 : VCR 3
- S-47 : VDP
- S-48 : TV
- S-49 : VIDEO
- S-51 : TAPE 1/DAT
- S-52 : TAPE 2
- S-53 : LINE
- S-54 : CD
- S-55 : TUNER
- S-56 : PHONO
- S-58 : SLEEP
- S-59 : RECEIVER POWER
- S-60 : MUTING
- S-61 : FRONT BAL.R
- S-62 : FRONT BAL.L
- S-63 : MASTER VOLUME-
- S-64 : MASTER VOLUME+
- S-65 : REAR LEVEL-
- S-66 : REAR LEVEL+
- S-67 : SURROUND MODE
- S-68 : SURROUND DELAY TIME
- S-69 : REAR BAL.R
- S-70 : REAR BAL.L
- S-73 : CENTER LEVEL-
- S-74 : CENTER LEVEL+
- S-75 : SOUND FIELD
- S-76 : ACOUSTIC
- S-77 : SP-A
- S-78 : SP-B
- S-80 : RETURN

- IC01 : PD5108-A
- IC02 : AZC1045
- IC03 : AZC1046
- IC04 : AZC1047
- IC05 : AZC1048
- Q01, Q02 : AZC1050
- Q03, Q04 : AZC1051
- Q05 : AZC1052
- D03-D06 : AZC1049
- D01, D02, D7-D15 : AZC1233
- PHD01 : AZC1055
- LED01, LED02 : AZC1053
- LED01, LED02 : AZC1054

10. PANEL FACILITIES

Illustration shows VSX-4500S

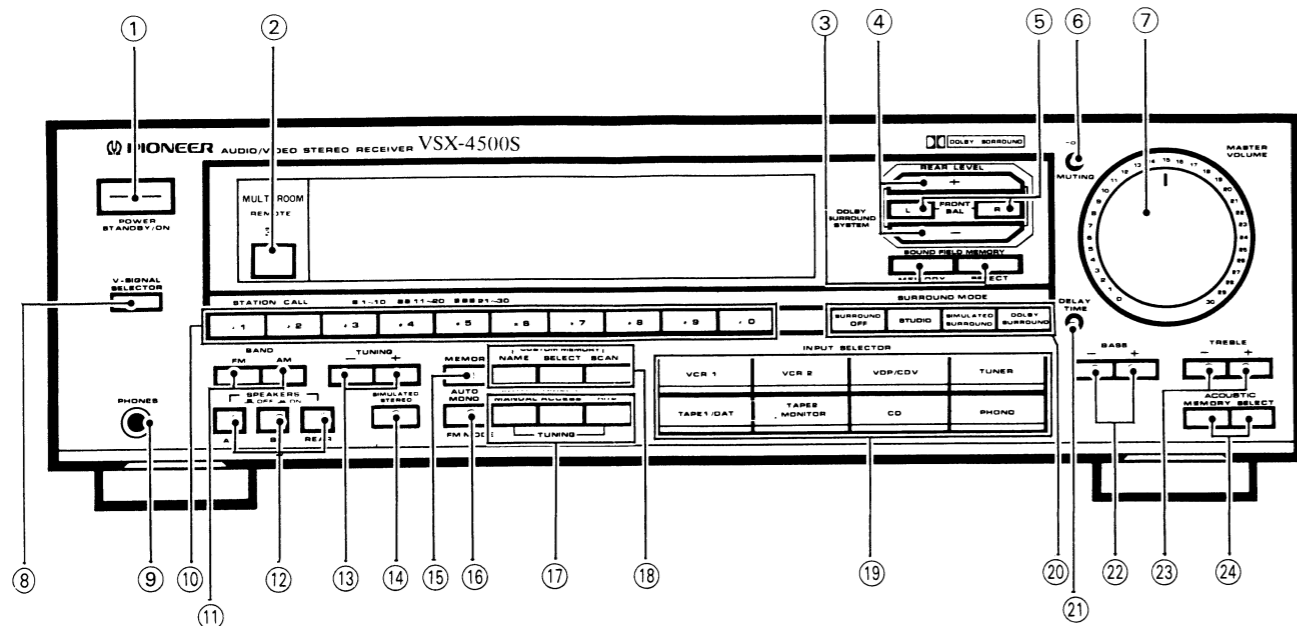

① POWER STANDBY/ON switch

- When this switch is pressed, power is supplied to the unit. Press the switch again to turn power standby.

[Timer ON/OFF possible]

When the unit is switched ON, ON/OFF control can be performed by means of the optional timer.

NOTE:

When the power is initially turned ON, muting will be applied to prevent sound from being output for about 5 seconds.

② Remote sensor

③ SOUND FIELD MEMORY switches

MEMORY:

Pressing this switch will result in the memorization of the sound field condition. Press again to cancel this mode.

SELECT:

- This switch is used to preset the five sound field memories (A-E).
- This switch is also used to recall previously set sound field settings. Each time you press the switch, the sound field setting advances in the order shown below.

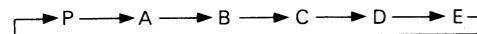

P: The sound field setting previously memorized in the unit.

④ REAR LEVEL (-, +) switches

Operate only when the surround mode is on.

These switches are used to preset the sound level difference between the front and surround speakers. In this way, after presetting the difference, the overall volume of the front and surround speakers can be changed using the MASTER VOLUME control, while still maintaining the sound volume differential.

-: Surround speaker volume is reduced.

+: Surround speaker volume is increased.

Press - and + together to restore front and surround to the default volume balance setting.

⑤ FRONT BAL switches

Use them to adjust the sound volume balance between left and right speakers.

L: Press to decrease the sound on the right side.

R: Press to decrease the sound on the left side.

Press L and R together to bring the volume balance back to center.

NOTE:

The left-right sound volume balance cannot be adjusted on the rear speakers.

⑥ MUTING switch

Press to temporarily cut off the sound volume. The display section MUTING indicator will flash. When pressed again, the sound will return to its previous level.

⑦ MASTER VOLUME control

Use it to simultaneously adjust the sound volume from the front and rear speakers.

⑧ V-SIGNAL (VIDEO SIGNAL) SELECTOR switch

When recording simulcast programs, the recorded image can be selected from among VCR 1, VCR 2 and VDP.

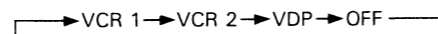

The current setting is shown by an indicator on the display section.

⑨ PHONES jack

Connect the plug on your headphones to this jack. Set all SPEAKERS A, B and REAR switches to OFF if you want to cut the sound from speakers and listen to it only through the headphones.

⑩ STATION CALL switches

Up to 30 FM or AM stations can be preset at random.

These switches are used to preset and recall desired broadcasting stations, FM AUTO/MONO mode.

NOTE:

Pressing a BAND selector switch or STATION CALL switch will select TUNER as the source, regardless of what other listening source or function was selected.

⑪ BAND selector switches

FM: Press for FM reception.

AM: Press for AM reception.

⑫ SPEAKERS switches (A, B, REAR) OFF ON

ON/OFF switches for the A, B and REAR (surround) speaker systems.

⑬ TUNING switches

+: Performs tuning from the currently displayed station frequency in ascending frequency order.

-: Performs tuning in order to descending frequencies.

⑭ SIMULATED STEREO switch

Press to produce a simulated stereo effect when listening to monaural sources (for example, normal AM or TV broadcasts).

"SIMULATED STEREO" appears on the display section.

NOTE:

This effect is not produced through the rear speakers.

Use with the SURROUND MODE in the OFF or SIMULATED SURROUND position (There is no effect in the STUDIO or DOLBY SURROUND positions). With a monaural source, it is more effective if used together with SIMULATED SURROUND.

⑮ MEMORY switch

When the unit is in the frequency display mode, pressing this switch will result in the memorization of the current broadcast band, reception frequency, and FM AUTO/MONO mode.

This switch is also used to input custom memory names (see page 23).

⑯ FM MODE AUTO/MONO selector switch

Use to select the auto stereo mode or monaural mode when listening to FM broadcasts. The monaural mode has been selected when the FM MONO indicator in the display section is lit.

Auto stereo mode:

Normally, leave in this mode for reception. When a stereo FM broadcast is received, it will be automatically reproduced in stereo.

Monaural mode:

When receiving distant stations or stations with weak broadcast signals, the input signal may be weak, thus resulting in increased noise during FM stereo broadcasts. In this event, setting the receiver to the monaural mode will reduce the noise. In this case, however, FM stereo broadcasts will be reproduced in monaural sound.

NOTE:

This switch has no effect on reception of AM broadcasts.

⑰ TUNING switches

AUTO/MANUAL TUNING selector switch:

This switch is used to select the tuning mode. The TUNING AUTO indicator lights when the AUTO tuning mode has been selected. The TUNING MANUAL indicator lights when the MANUAL tuning mode has been selected (see page 21).

AUTO tuning

When the - or + TUNING switch is pressed, the receiver automatically scans the broadcast station frequencies. When a broadcast is detected, the scanning stops at that frequency.

NOTE:

Pressing the TUNING switch (- or +) while scanning is taking place causes scanning to stop.

MANUAL tuning

This lets you manually tune to particular broadcast frequencies. Each press of the + or - switch raises or lowers the frequency by one tuning step. For continuous scanning, keep the switch pressed, then release it to stop scanning.

DIRECT ACCESS TUNING switch:

When this switch is pressed, the STATION CALL switches function as ten-key number switches for direct input of the desired reception frequency. Press again to cancel this mode.

If the input station falls outside of the receiver's tuning range, the display section will display a message: "UPPER" if the frequency is too high and "LOWER" if it is too low (see page 21).

HITS (Hyper Intelligent Tuning System) switch:

- If the HITS switch is pressed during input of numbers for DIRECT ACCESS tuning, the receiver sets the remaining digits which have not yet been input to "0," searches for the corresponding frequencies, and stops on the first station it finds.

- If the HITS switch is pressed at the currently displayed station frequency, the receiver searches up and down the frequency for the next station (The SEARCH indicator in the display section lights at this time.) and stops at the first one it finds.

(FM)

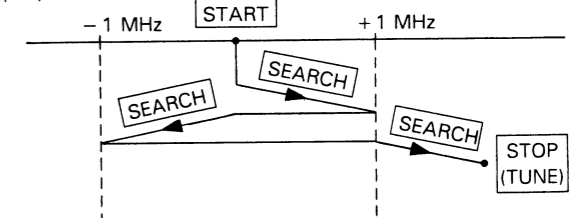

NOTE:

- The system searches for stations within successive 1 MHz ranges for FM and 100 kHz ranges for AM. During DIRECT ACCESS tuning, it searches up and down for a station until it reaches the edges of the band. If no receivable station is found within the band range, the receiver returns to the state it was in before the HITS switch was pressed.

- If the upper (or lower) frequency limit of the receiver is encountered during HITS operation, the receiver stops searching in that direction but continues to search in the other.

⑱ CUSTOM MEMORY switches

Stations can be assigned to STATION CALL switches according to the genre of material broadcast (for example, ROCK, JAZZ, etc.). You can recall a particular genre, and scan all the stations of that genre with Memory Scan until you reach the desired one.

The initial settings are ROCK, POP, JAZZ, NEWS, and PARTY.

NAME switch

Change the name of a genre with this switch.

SELECT switch

Recall a genre name with this switch.

SCAN switch

Use this switch to carry out Memory Scan within a genre recalled with the SELECT switch.

If it is pressed when "TUNER" is displayed, Memory Scan of successive STATION CALL NUMBERS and not genre will occur.

19 Audio/Video INPUT SELECTOR switches

VCR 1: Press when performing playback on a VCR unit.
VCR 2: Press when performing playback on a second VCR unit.
VDP/CDV: Press when performing playback on a video disc player (VDP) or CDV player.
TUNER: Press when listening to radio broadcasts.
TAPE 1/DAT: Press when performing playback on a DAT or cassette deck.
TAPE 2 MONITOR: Press when performing playback on a second cassette deck or second DAT and when monitoring recording.
CD: Press when playing compact discs on a CD player.
PHONO: Press when playing records on turntable.

20 SURROUND mode selector switches

OFF:
 To cancel the surround function.

STUDIO:
 Select this setting to enjoy the effect of listening to music recording studio.

SIMULATED SURROUND:
 Select this setting when listening to music or a monaural source, etc. With a monaural source, a much better surround effect is achieved if it is used together with SIMULATED STEREO.

DOLBY SURROUND
 Select this setting when watching video tapes or video discs bearing the  **DOLBY SURROUND** mark.

21 DELAY TIME switch

Operates when the SIMULATED or DOLBY SURROUND mode is ON. Switches to surround delay time in three steps. For DOLBY SURROUND, 20 ms is standard.

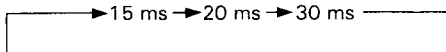

22 BASS control switches

Use to adjust the low-frequency level. Press the + switch to increase low-frequency level, and the - switch to decrease it. The TONE indicator appears on the display section. When both switches (+, -) of the BASS control are pressed simultaneously, the bass response will be set to the flat (normal) condition.

23 TREBLE control switches

Use to adjust the high-frequency level. Press the + switch to increase high-frequency level, and the - switch to decrease it. The TONE indicator appears on the display section. When both switches (+, -) of the TREBLE control are pressed simultaneously, the treble response will be set to the flat (normal) condition.

24 ACOUSTIC switches

MEMORY:
 Pressing this switch will result in the memorization of the sound quality (tone control condition). Press again to cancel this mode.

SELECT:

- This switch is used to preset the five acoustic memories (A–E).
- This switch is also used to recall previously set sound quality settings. Each time you press the switch, the sound quality setting advances in the order shown below.

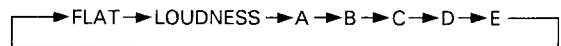

FLAT: For flat (normal) frequency response.

LOUDNESS: Emphasizes the low- and high- frequency ranges. Produces a fuller sense of sound, particularly when listening at low volume.

A–E: Memorized acoustic memory settings.

DISPLAY SECTION

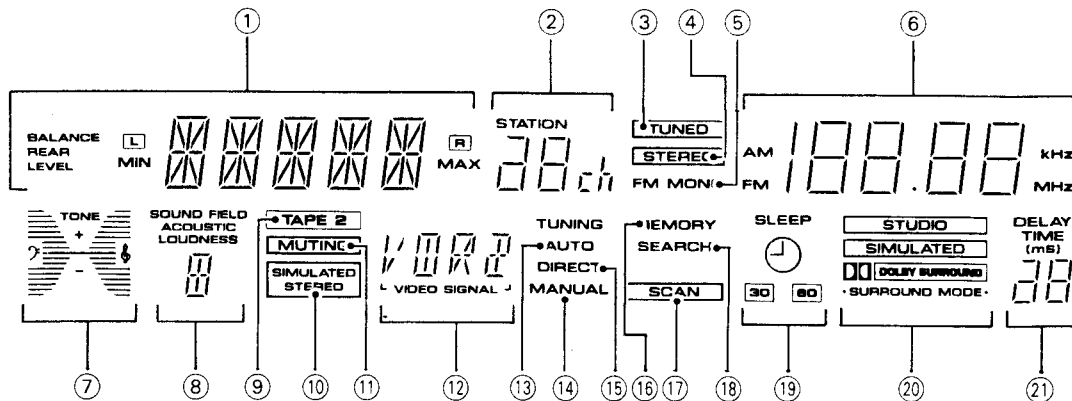

[DISPLAY SECTION]

① CHARACTER/LEVEL/BALANCE display

This displays the name of the component selected with the INPUT SELECTOR. It also displays the level and balance settings during adjustment.

② STATION No. display

Shows the channel selected with the STATION CALL switch.

③ TUNED indicator

Lights up when a station is tuned in during TUNER operation.

④ STEREO indicator

Lights up when a stereo FM broadcast is being received.

⑤ FM MONO indicator

Lights up when the FM MONO mode is selected with the FM MODE switch.

⑥ Frequency display

⑦ TONE level indicator

Shows the settings of the BASS and TREBLE switches.

⑧ SOUND FIELD/ACOUSTIC display

Shows the setting of the SOUND FIELD and ACOUSTIC.

⑨ TAPE 2 indicator

Lights up when the INPUT SELECTOR is set to TAPE 2 MONITOR ON.

⑩ SIMULATED STEREO indicator

⑪ MUTING indicator

Flashes when MUTING in ON.

⑫ VIDEO SIGNAL SELECTOR indicators

Shows the video component selected with the VIDEO SIGNAL SELECTOR switch.

⑬ AUTO TUNING indicator

Lights up when in the auto tuning mode.

⑭ MANUAL TUNING indicator

Lights up when in the manual tuning mode.

⑮ DIRECT TUNING indicator

Lights up when in the direct access-tuning mode.

⑯ MEMORY indicator

⑰ SCAN indicator

Lights up during memory scan operation.

⑱ SEARCH indicator

⑲ SLEEP timer indicators

Shows the SLEEP timer setting (the length of time from the set time to the point at which power will switch off). (The sleep timer can be operated via the remote control.)

⑳ SURROUND MODE indicators

㉑ DELAY TIME display

Shows the delay time during surround operation.

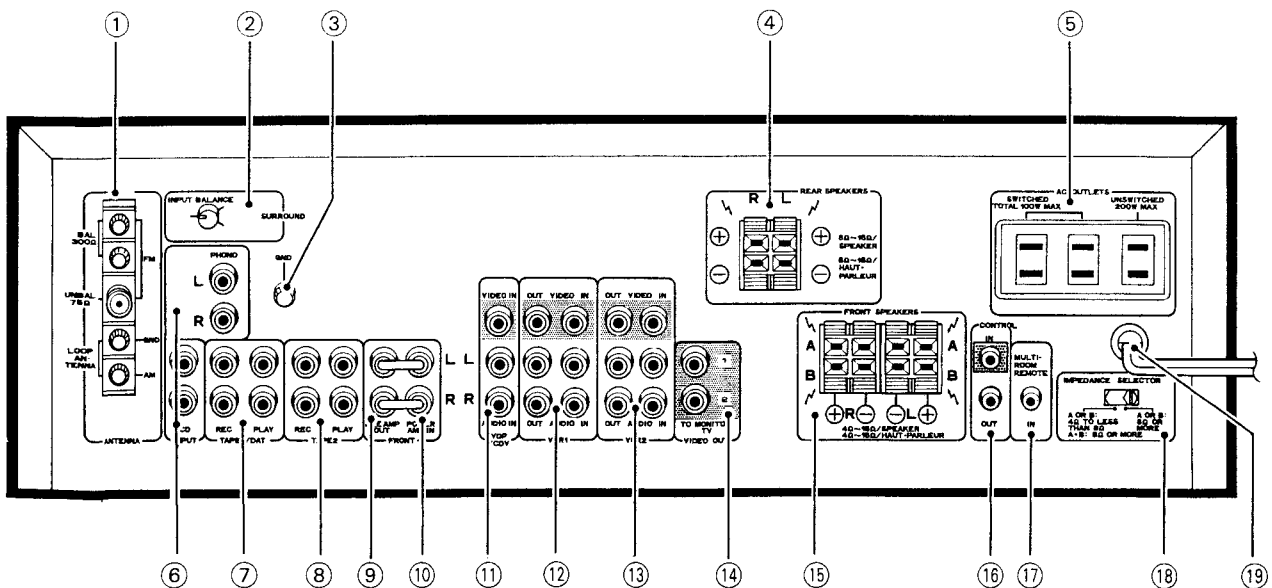

① FM/AM ANTENNA terminals

Use these antenna terminals for reception of normal FM and AM broadcasts.

② SURROUND INPUT BALANCE control

This knob is for adjusting the balance of the DOLBY SURROUND input signal. To adjust, apply a monaural sound signal and rotate until the SURROUND (rear) sound becomes minimum. (See page 29.)

③ GND terminal

Connect the turntable ground lead to this terminal.

④ REAR SPEAKERS terminals

Connect the surround speakers to these terminals.

NOTE:

Do not allow any of the cord's conductors to protrude from the terminals or touch any other conductors. Malfunctioning or breakdowns may occur when conductors come into contact with each other. Use surround speakers of impedance 8Ω — 16Ω.

⑤ AC OUTLETS

[SWITCHED TOTAL 100 W MAX]

Power supplied through these outlets is turned on and off by the receiver's POWER switch. Total electrical power consumption of connected equipment should not exceed 100 W.

[UNSWITCHED 200 W MAX]

Power flows continually to this outlet, regardless of whether the receiver is switched ON or OFF. Electrical power consumption of the connected equipment should not exceed 200 W.

The equipment should be disconnected by removing the power plug from the wall socket when not in regular use, e.g. when on vacation.

NOTE:

Do not connect appliances with high power consumption such as heaters, irons, or television sets to the AC OUTLETS in order to avoid overheating or fire risk. This can cause the receiver to malfunction.

⑥ INPUT jacks

PHONO Connect to the output cables from a turntable.

CD Connect to the output jacks of a compact disc player.

⑦ TAPE 1/DAT jacks

Use these to connect a first cassette deck or first DAT (digital audio tape deck).

Connecting for Recording

The tape recording jack (REC) on the cassette deck or DAT should be connected to the REC side of the TAPE 1/DAT jack on the receiver with a pin plug connecting cord.

Connecting for Playback

Connect the PLAY jack on the cassette deck or DAT to the PLAY side of the TAPE 1/DAT jack on the receiver with a pin plug connecting cord.

⑧ TAPE 2 jacks

Connect a second cassette deck to these jacks.

Connecting for Recording

The tape recording jack (REC) on the cassette deck should be connected to the REC side of the TAPE 2 jack on the receiver with a pin plug connecting cord.

Connecting for Playback

Connect the TAPE PLAY jack on the cassette deck to the PLAY side of the TAPE 2 jack on the receiver with a pin plug connecting cord.

⑨ FRONT PRE-AMP OUT jacks

When a separate power amplifier is used to drive the front speakers, connect the power amplifier to these jacks.

⑩ FRONT POWER AMP IN jacks

When a separate pre-amplifier is connected and this unit is used as power amplifier, connect the pre-amplifier to these jacks.

⑪ VDP/CDV jacks

[VIDEO IN]

When watching the video image from a LD player (VDP) or a CDV player, connect its VIDEO OUTPUT jacks here.

[AUDIO IN (L,R)]

When playing back the audio channel from a LD player (VDP) or a CDV player, connect its AUDIO OUTPUT jacks here.

⑫ VCR 1 jacks

[VIDEO OUT]

When copying program material from the video component connected to the VCR 2 or VDP/CDV jacks, connect to the VIDEO INPUT jacks of the VCR used for recording.

[AUDIO OUT (L, R)]

When copying program material from the video component connected to the VCR 2 or VDP/CDV jacks, or when recording music from an audio component source, connect to the AUDIO INPUT jacks of the VCR used for recording.

[VIDEO IN]

When monitoring the video image from a VCR used for playing, connect its VIDEO OUTPUT jacks here.

[AUDIO IN (L, R)]

When monitoring back the audio channel from a VCR used for playing, connect its AUDIO OUTPUT jacks here.

⑬ VCR 2 jacks

[VIDEO OUT]

When copying program material from the video component connected to the VCR 1 or VDP/CDV jacks, connect to the VIDEO INPUT jacks of the VCR used for recording.

[AUDIO OUT (L, R)]

When copying program materials from the video component connected to the VCR 1 or VDP/CDV jacks, or when recording music from an audio component source, connect to the AUDIO INPUT jacks of the VCR used for recording.

[VIDEO IN]

When monitoring the video image from a VCR used for copying, connect its VIDEO OUTPUT jacks here.

[AUDIO IN (L, R)]

When monitoring the audio channel from a VCR used for copying, connect its AUDIO OUTPUT jacks here.

⑭ VIDEO OUT TO MONITOR TV jacks

Connect to monitor TV or to TV sets with video input terminals for watching program materials from a VCR or VDP/CDV connected to this unit.

15 SPEAKERS (FRONT) terminals

A: Connect to a first set of speakers.

B: Connect to a second set of speakers.

Speaker lead wire preparation and connection.

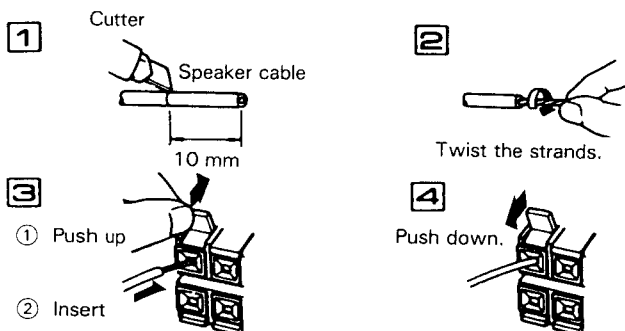

NOTE:

Do not allow any of the cord's conductors to protrude from the terminals or touch any other conductors. Malfunctioning or breakdowns may occur when conductors come into contact with each other.

Use speakers of impedance $4\Omega - 16\Omega$. Also set the **IMPEDANCE SELECTOR switch** to match the impedance of your speakers.

16 REMOTE CONTROL IN/OUT jacks

IN: Connect this jack to other Pioneer components (main unit or remote control unit) when using those components to control this unit.

OUT: Connect this jack to other Pioneer components when using the remote control of this unit to control the other components.

NOTE:

The receiver's remote sensor does not function when a plug is inserted in the IN jack. To operate, point the remote control unit at the remote sensor on the component to which the receiver's IN jack is connected.

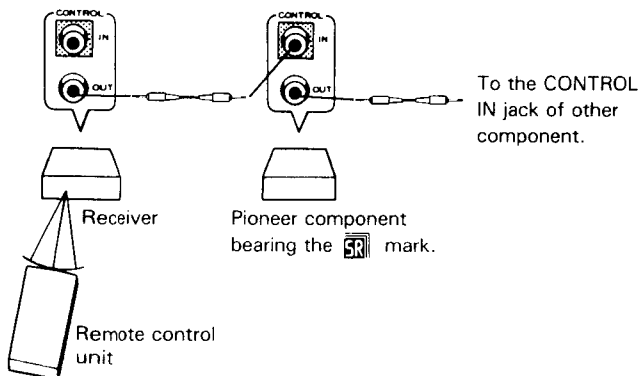

17 MULTI-ROOM REMOTE IN jack

Connect the adaptor (MR-100, sold separately) to this Multi-Remote IN jack. You can operate the unit by remote control through the adaptor.

It is convenient when the unit is located in a separate room.

18 IMPEDANCE SELECTOR switch

Set this switch to match the impedance of your speakers.

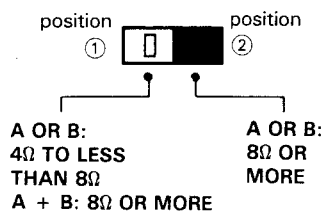

• When using a pair of speakers:

Impedance of a speaker	Selector position
4Ω to less than 8Ω	①
8Ω or more	②

• When using two pairs of speakers:

Select ① as the selector switch position and use speakers having impedance of 8 ohms or more.

NOTE:

Turn off the receiver's power before changing the impedance selector switch setting.

19 Power cord

Manufactured under license from Dolby Laboratories Licensing Corporation. Additionally licensed under one or more of the following patents: U.S. numbers 3,632,886, 3,746,792 and 3,959,590; CANADA numbers 1,004,603 and 1,037,877. "Dolby" and the double-D symbol are trademarks of Dolby Laboratories Licensing Corporation.

Manufacturé sous licence de Dolby Laboratories Licensing Corporation. En outre, sous licence d'un ou plusieurs des brevets suivants: numéros américains 3,632,886, 3,746,792 et 3,959,590; numéros canadiens 1,004,603 et 1,037,877. Le terme "Dolby" et le symbole Double-D sont des marques déposées de Dolby Laboratories Licensing Corporation.

11. SPECIFICATIONS

Amplifier section

[POWER AMP IN]

Continuous average power output of 100 watts* per channel, min., at 8 ohms, from 20 Hz to 20,000 Hz with no more than 0.008 % total harmonic distortion (front); 15 watts* per channel, min., at 8 ohms, from 40 Hz to 15,000 Hz with no more than 0.4 %** total harmonic distortion (rear).**

Dynamic Power (2 Ω/4 Ω/8 Ω)	230 W/200 W/150 W
Input (Sensitivity/Impedance)	
PHONO MM	2.5 mV/47 kΩ
CD, TAPE 1/DAT, TAPE 2, VDP/CDV,	
VCR 1, VCR 2	150 mV/47 kΩ
FRONT POWER AMP IN	1 V/47 kΩ
Phono Overload Level (T.H.D. 0.08 %, 1000 Hz)	
PHONO MM	130 mV
Frequency Response	
PHONO MM	20 Hz to 20,000 Hz ±0.3 dB
CD, TAPE 1/DAT, TAPE 2, VDP/CDV,	
VCR 1, VCR 2	5 Hz to 100,000 Hz ± $\frac{0}{3}$ dB
Output (Level/Impedance)	
TAPE 1/DAT REC, TAPE 2 REC	150 mV/2.2 kΩ
VCR 1 OUT, VCR 2 OUT	150 mV/2.2 kΩ
PRE AMP OUT	1 V/470Ω
Tone Control	
BASS 100 Hz	± 8 dB
TREBLE 10 kHz	± 8 dB
Loudness Contour	6 dB (100 Hz)
	3 dB (10 kHz)
Signal-to-Noise Ratio (IHF, short circuited, A network)	
PHONO MM	73 dB
CD, TAPE 1/DAT, TAPE 2, VDP/CDV,	
VCR 1, VCR 2	98 dB
Signal-to-Noise Ratio [EIA, at 1 W (1 kHz)]	
PHONO MM	75 dB
CD, TAPE 1/DAT, TAPE 2, VDP/CDV,	
VCR 1, VCR 2	80 dB

* Measured pursuant to the Federal Trade Commission's Trade Regulation rule on Power Output Claims for Amplifier.

** Measured by Audio Spectrum Analyzer.

VIDEO Section

Input (Sensitivity/Impedance)	
VCR 1, VCR 2, VDP/CDV	1 Vp-p/75Ω
Output (Level/Impedance)	
VCR 1, VCR 2, MONITOR	1 Vp-p/75Ω
Frequency Response	
VCR 1, VCR 2, VDP/CDV→MONITOR	5 Hz — 10 MHz ± $\frac{0}{3}$ dB
Signal to noise ratio	55 dB
Cross Talk	55 dB

FM Tuner Section

Frequency Range	87.5 MHz to 108 MHz
Usable Sensitivity	Mono; 10.8 dBf, IHF (0.95 μV/75 Ω)
50 dB Quieting Sensitivity	Mono; 15.3 dBf, (1.6 μV/75 Ω)
	Stereo; 37.0 dBf, (19.5 μV/75 Ω)
Signal-to-Noise Ratio	Mono; 80 dB (at 65 dBf)
	Stereo; 76 dB (at 85 dBf)
Distortion	Mono; 0.2 % (1 kHz)
	Stereo; 0.3 % (1 kHz)
Capture Ratio	1 dB
Alternate Channel Selectivity	65 dB (400 kHz)
Stereo Separation	45 dB (1 kHz)
Frequency Response	30 Hz to 15 kHz (± $\frac{0}{2.5}$ dB)
Image Interference Ratio	50 dB
IF Interference Ratio	80 dB
Antenna Input	300 Ω balanced
	75 Ω unbalanced

AM Tuner Section

Frequency range	530 kHz — 1,700 kHz
Sensitivity (IHF, Loop antenna)	300 μV/m
Selectivity	25 dB
Signal-to-Noise Ratio	50 dB
Antenna	Loop antenna

Miscellaneous

Power requirements	AC 120V, 60 Hz
Power consumption	400 W, 510 VA
In standby condition	3 W
AC Outlets	
SWITCHED x 2	TOTAL 100 W MAX
UNSWITCHED x 1	200 W MAX
Dimensions	420 (W) x 125.5 (H) x 395 (D) mm
	16-7/16 (W) x 4-15/16 (H) x 15-9/16 (D) in
Weight (without package)	9.5 kg (21 lb)

Furnished Parts

FM T-type antenna	1
AM Loop antenna	1
Dry cell battery	
VSX-4500S size "AAA" (LR03/AM-4) Alkaline	4
VSX-4400 size "AAA" (R03/UM-4)	2
Remote control unit	1
Operating Instructions	1
Template (VSX-4500S)	2

NOTE:

Specifications and the design subject to possible modifications without notice due to improvements.